



PARISOT INDUSTRIE



Details

SUMMER
2023



SUMMARY

SUMMER EDITION

KID BEDROOMS

BIBLIOBED.....	1
BIBOP 2.....	3
BIOTIFUL.....	5
CHARLY.....	7
ESCALE.....	9
FABRIC.....	11
FINLAND.....	13
GALAXY.....	15
HEAVY.....	17
HIGHER.....	19
LEGEND.....	21
LEO.....	23
LUCAS.....	25
MILKY.....	27
NASHVILLE.....	29
ONLINE.....	31
PIROUETTE.....	33
REVERSE.....	37
SHELTER.....	38
SLEEP.....	44
SMOOZY.....	46
SNOOP.....	48
STIM 2.....	50
TOBO.....	52
TOM.....	54

ADULT BEDROOMS

AALBORG.....	57
BIANCA.....	69
BRIDGE.....	60
EKKO.....	62
ESCALE.....	64
EVO II.....	66
LODGE.....	68
MORPHEUS.....	70
MOST.....	72
NASHVILLE.....	74
ORION.....	76
SANTORIN.....	78
SOLUCE.....	80
STAMP.....	82
TORONTO.....	86
TRAVEL.....	88

LIVING ROOMS

AXEL.....	91
FUMAY.....	92
HELMA.....	94
JULES.....	96
NALA.....	98
PORTLAND 2.....	99
SHADE.....	101
TOMY 2.....	103
TRAVIS.....	104
WENDY.....	105

STORAGES & FURNITURES

CELEST.....	108
DAILY 2.....	110
EXTENSO.....	112
GALAXY.....	115
GAMING.....	117
GHOST.....	119
LEGEND.....	120
LUDIK.....	122
MARGAUX.....	123
MAYENCE.....	125
MILO.....	127
MINKEE.....	128
ORLANDO.....	130
SOPHIA.....	132

DESKS

BACK UP.....	135
BEGIN.....	136
GAMING.....	137
INDEX.....	139
INFINITY.....	141
LEVEL.....	143
MINISTER.....	145
MISTER.....	146
SCHOOL.....	147
SET UP.....	148
START UP.....	150

BEAUTY BARS

AALBORG.....	153
SWEET.....	155
VOLAGE.....	156



KID BEDROOMS

KID BEDROOM / Bibliobed



✦ A bunk bed with two more distinct sleeping areas than a conventional bunk bed

✦ A shaped ladder with **large, non-slip steps** for easy and safe access to the top bunk

✦ An integrated **two-level layout** with open storage space under the staircase and two large platforms next to the sleeping areas that can be used as bedside cabinets or bookcases



WHITE

JACKSON OAK

The products are made of particleboards with a thickness of 15 and 22 mm

KID BEDROOM / Bibliobed



The **BIBLIOBED** bunk bed includes :

- Two bunk beds with dimensions of 90x200 cm including bed bases and accessible via a ladder with three large non-slip steps
- An extra pull-out bed available as an option
- An open storage space located under the staircase and accessible from either side of it
- Two 2-meters long laying platforms with 3 storage compartments each, located next to the two sleeping areas

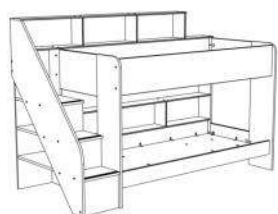

2332LISU : L245 x H171 x D111
Weight : 167 kg - Volume : 0.335m³
Number of packages : 5

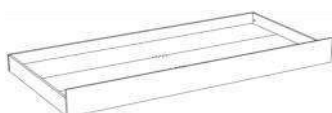

2332TILI : L199 x H19 x D95
Weight : 24 kg - Volume : 0.055m³

KID BEDROOM / Bibop 2



✦ A two-level sleeping solution with plenty of storage space provided by a 3-compartment installation platform on each level and ample space under the ladder steps

✦ Available in its **Light Acacia** version, this bunk bed has **Brown | Pink** reversible shelves

✦ It is also equipped with a ladder made up of three large steps with an anti-slip system and a metal handrail for **easy and safe access** to the top bunk



LIGHT ACACIA

PINK

The products are made of particleboards with a thickness of 12, 15 and 22 mm

KID BEDROOM / Bibop 2



The bunk bed **BIBOP2** includes :

- Two 90x200 cm bunk beds (including bed base) accessible via a three-step ladder
- Multiple storage spaces under the large steps of the ladder
- An extra pull-out bed available as an option
- Two storage spaces with three 28 cm high compartments and two bedside platforms
- Brown | Pink reversible shelves

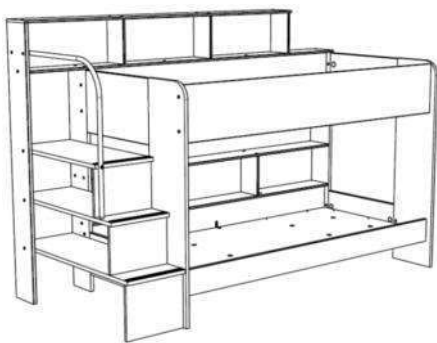

Dimensions : L245 x H171 x D114
Weight : 177 kg - Volume : 0.350m³
Number of packages : 5

2326LISU : Light Acacia version + Brown | Pink reversible shelves

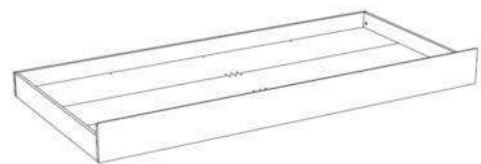

Dimensions : L199 x H19 x D95
Weight : 24 kg - Volume : 0.055m³

2326TILI : Light Acacia version

KID BEDROOM / Biotiful



✦ Plush furniture inspired by the seaside theme with **Pink | White** decor and equipped with beautiful translucent pink handles for an original and girly look !

✦ A complete bedroom with sturdy furniture and **neat finishes**, with plenty of storage space and two different sleeping sizes (90x190 cm and 90x200 cm)



The products are made of particleboards with a thickness of 16 and 22 mm

The drawers are equipped with a roller runner system (with balls for the bedside)

INDIAN PINK WHITE



The girly bedroom **BIOTIFUL** includes :

- A plush low bed available in 90x190 cm and 90x200 cm
- A large 3-door 2-drawer wardrobe with a wide mirror
- A chest of drawers composed of 3 drawers with double handles
- A desk with child-friendly workspace, closed storage and lower shelf
- A bedside table with storage compartment and shaped drawer



2273LI90 : L103 x H79 x D197
Weight : 28 kg - Volume : 0,057m3
Number of packages : 2



2273L290 : L103 x H79 x D207
Weight : 28 kg - Volume : 0,058m3
Number of packages : 2



2273BURE : L121 x H77 x D65
Weight : 40 kg - Volume : 0,092m3



2273CHEV : L48 x H42 x D33
Weight : 10 kg - Volume : 0,022m3



2273CO3T : L90 x H79 x D45
Weight : 33 kg - Volume : 0,071m3

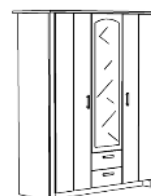

2273A3PT : L136 x H181 x D56
Weight : 105 kg - Volume : 0,201m3
Number of packages : 3

KID BEDROOM / Charly



✚ Enjoy a lot of storage space with the Charly collection made of beautiful **Light Acacia | White** furniture with a silver-grey decoprint that is both decorative and recreational

✚ A complete room available at a low price and offering different beds:

- A combined bed
- A low bed
- Two functional beds with step and drawer on wheels! (90x190 cm and 90x200 cm)



The products are made of particleboards with a thickness of 15 and 22 mm

The drawers are equipped with a roller runner system (chest of drawers, 3-door wardrobe) or a ball bearing runner system (desk, bedside table)

LIGHT ACACIA

WHITE

KID BEDROOM / Charly



The mixed bedroom **CHARLY** includes :

- A functional bed with step and drawer available in 90x190 cm and 90x200 cm
- A 90x190 cm low bed and a 90x200 cm combined bed
- A reversible assembly environment
- A desk with a drawer
- A chest of drawers composed of 3 drawers
- A bedside table with a drawer
- A two-door wardrobe with a top shelf and a hanging bar
- An other three-door wardrobe with a hanging bar and a drawer



2498LITM : L121 x H67 x D193 |
Weight : 31 kg - Volume : 0.064m3 |
Number of packages : 2

2498L2TM : L121 x H67 x D203 |
Weight : 32 kg - Volume : 0.064m3 |
Number of packages : 2



2498A2PT : L85 x H180 x D52
Weight : 63 kg - Volume : 0,134m3
Number of packages : 2



2498A3PX : L112 x H180 x D52
Weight : 73 kg - Volume : 0,149m3
Number of packages : 2



2498CH1T : L44 x H40 x D28
Weight : 7 kg - Volume : 0,018m3



2498COMB : L206 x H110 x D183
Weight : 104 kg - Volume : 0,227m3
Number of packages : 4

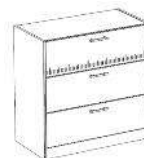

2498CO3T : L78 x H82 x D40
Weight : 25 kg - Volume : 0,052m3



2498BURE : L109 x H75 x D59
Weight : 22 kg - Volume : 0,048m3



2498ENVI : L123 x H93 x D29
Weight : 19 kg - Volume : 0,045m3

KID BEDROOM / Escale



✦ Did you like the adult Escale range ?
Discover the kid's version !

✦ The Escale bed adapts to your room thanks to its shelves, which can be assembled on the left or right handside of the bed. This way, you can dress up your wall with its headboard and these shelves that serve as bedside table. Add optional drawers to optimise your storage space.

✦ Its 3-door wardrobe has an inside mirror and a reversible **Oak** or **White** vertical panel. Complete your storage space with its harmonious 1-door 3-drawer chest.

✦ The Escale range is inspired by the Japandi trend, with a worked design. This bedroom features hand-grip handles and discreet decorative mouldings. The **Japanese Oak** colour will give your kid's bedroom a warm, harmonious and trendy feel.



JAPANESE OAK



The products are made from 15 and 22 mm thick particleboard.

The chest drawers are fitted with a roller runner system

KID BEDROOM / Escale



The ESCALE bedroom includes

- A 90x190-200cm bed with a headboard with shelves used as a bedside table
- A set of two 51 cm deep drawers available as an option
- A chest of 3 drawers and a door
- A 3-door wardrobe including 1/3 shelving part (3 shelves) and 2/3 hanging part and inside mirror.



3580L290: L122 x H89 x P217;
Weight : 38kg - Volume : 0,081m3;
Number of packages : 2

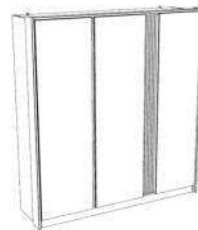

3580AR3P : L185 x H203 x P52;
Weight : 130 kg - Volume :
0,275m3; Number of packages : 4

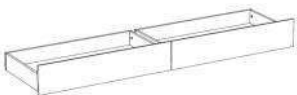

3580T2RO : L199 x H22 x P51;
Weight : 13 kg - Volume : 0,031m3;
Number of packages : 1



3580COPT : L110 x H77 x P50.
Weight : 42 kg - Volume :
0,084m3. Number of packages : 2

KID BEDROOM / Fabric



✦ A clever and functional collection including beautiful furniture with **large storage volumes**, including a bed with a drawer at the front (plus an optional set of two side drawers), a bedside table with a reversible door and a desk with extension equipped with closed storage compartments

✦ With its steel handles and its decoprint impression, this "urban" style bedroom is perfect for pre-teens who want to assert their character



The products are made of particleboard with a thickness of 12,15 and 22 mm
The drawers are equipped with a roller runner system (ball-bearing for the bedside table)

DARK GREY

LOFT GREY

KID BEDROOM / Fabric



The urban style bedroom **FABRIC** includes :

- A bed with a large 48 cm deep drawer at the front (plus an optional set of two side drawers)
- A 2-door wardrobe with two 48 cm deep open storage spaces
- A desk with extension equipped with a drawer, a closed storage compartment and a 24 cm deep platform
- A chest of drawers with three 35 cm deep drawers
- A bedside table with a drawer including a reversible door



2311L2TI : L99 x H66 x D207
Weight : 31 kg - Volume : 0,065m3
Number of packages : 2



2311T2CO : L149 x H18 x D42
Weight : 14 kg - Volume : 0,038m3



2311BURE : L108 x H114 x D56
Weight : 29 kg - Volume : 0,06m3



2311CHEV : L40 x H45 x D28
Weight : 8 kg - Volume : 0,017m3



2311CO3T : L87 x H76 x D40
Weight : 28 kg - Volume : 0,058m3



2311AR2P : L101 x H182 x D51
Weight : 65 kg - Volume : 0,126m3
Number of packages : 2

KID BEDROOM / Finland



✦ A functional mixed combined bed in two-tone **White | Jackson Oak** for a natural style, suitable for both boys and girls

✦ Rounded ladder with ABS edges and two widened steps of 17 and 18 cm depth for optimal comfort of use

✦ A **space-saving solution**, with a bed placed at half height overhanging many storage compartments to optimize the available space



WHITE

JACKSON OAK

The products are made of particleboards with a thickness of 15 and 22 mm.

KID BEDROOM / Finland



The **FINLAND** combined bed includes :

- A 90x200 cm bed, halfway up and accessible via a ladder with two steps
- A storage space made up of four 35-cm-deep compartments
- A 90x65 cm removable desk with two storage compartments sized L:60 x H:33 cm
- A storage space at the bottom of the bed sized L:93 x W:40 cm

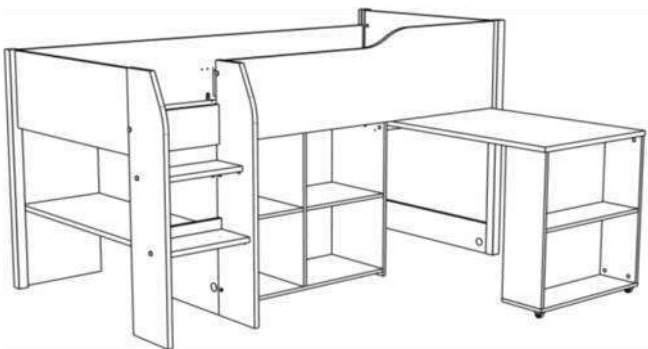

2530COMB : L209 x H118 x D183
Weight : 114 kg - Volume : 0.270m³
Number of packages : 5

KID BEDROOM / Galaxy



✚ A complete range including a **functional** bed with drawer, storage compartment and reversible platform, a 6-door and 3-drawer wardrobe, a 4-drawer chests of drawers, a bedside table with 1 drawer and a desk with 3 drawers

✚ A **white** look enhanced by modern feet and handles for an unisex design that's perfect for both boys and girls



WHITE

The products are made of particleboards with a thickness of 12,5 and 15 mm

The drawers are equipped with a ball-bearing runner system

KID BEDROOM / Galaxy



The mixed bedroom **GALAXY** includes :

- One bed with drawer, storage compartment and an integrated platform
- A 120-cm-length desk with 3 drawers
- 1 bedside table with 1 drawer
- 1 chest of 4 drawers of 25 cm high and 40 cm deep
- A 203-cm-high wardrobe with 6 doors and 3 drawers



1350L2TI : L120 x H74 x D203
Weight : 40 kg - Volume : 0,081m3
Number of packages : 2



5349BURE : L120 x H75 x D50
Weight : 25 kg - Volume : 0,056m3



5350CH1T : L40 x H41 x D33
Weight : 8 kg - Volume : 0,017m3



5354CO4T : L77 x H106 x D40
Weight : 32 kg - Volume : 0,068m3



5366A6PT : L146 x H203 x D55
Weight : 106 kg - Volume : 0,199m3
Number of packages : 4

KID BEDROOM / GRAYSON



A space for your child!

✦ Combining the functions of bed, wardrobe and desk, this high sleeper with its numerous storage spaces is ideal for creating a space where your child can grow freely.

✦ Choose your atmosphere with this functional and decorative masterpiece. Go for an industrial and retro style with the **Artisan Oak | Dark Grey** version or opt for a Scandinavian atmosphere with the soft colours of the **Jackson Oak | Home White** model.



The products are made of particle board, with a thickness of 15 and 22 mm
The drawers are equipped with a metal runner system with rollers

JACKSON OAK	DARK GREY
WHITE	ARTISAN OAK

KID BEDROOM / GRAYSON



The GRAYSON high sleeper includes :

- A 90x200 cm bed with a bed base and access via a four-step ladder
- A 130 cm long x 57 cm deep desk located under the bed and equipped with a drawer and a hutch.
- A closed cupboard-type storage space with shelves and a hanging rail
- A 160 cm long shelf located at the top and acting as a bedside



L204 x H178 x P116 ; Poids : 141 kg -

Volume : 0.295m³

Number of packages: 5

2380LSUR : Oak Artisan | Grey Shadow

2480LSUR: Jackson Oak | Home White

KID BERDOOM / HIGHER



✦ An integrated **two-level layout** with a closed storage space including a closet rod, a desk, two platforms and multiple storage compartments

✦ A sturdy product with a quality finish, thick edges and shaped parts with a thickness of 28 mm

✦ A 5-step ladder that allows easy and safe access to the top bunk



The products are made of particleboards with a thickness of 15 and 28 mm
The closed storage space is equipped with a roller runner system



The mezzanine bed **HIGHER** includes :

- A 90x200 cm sleeping area accessible through a 5-step ladder
- A desk of L133 x P66 cm under the bed
- Three L87 x D20 cm shelves providing numerous storage niches under the bed
- A closed storage space similar to a wardrobe equipped with a sliding door and including a closet rod
- One platform of W160 x D23 cm on the outside of the bed and another of W200 x D23 cm on the inside, above 2 additional storage niches



2410LSU2 : L206 x H189 x D138
Weight : 184 kg - Volume : 0.387m³
Number of packages : 7

KID BEDROOM / Legend

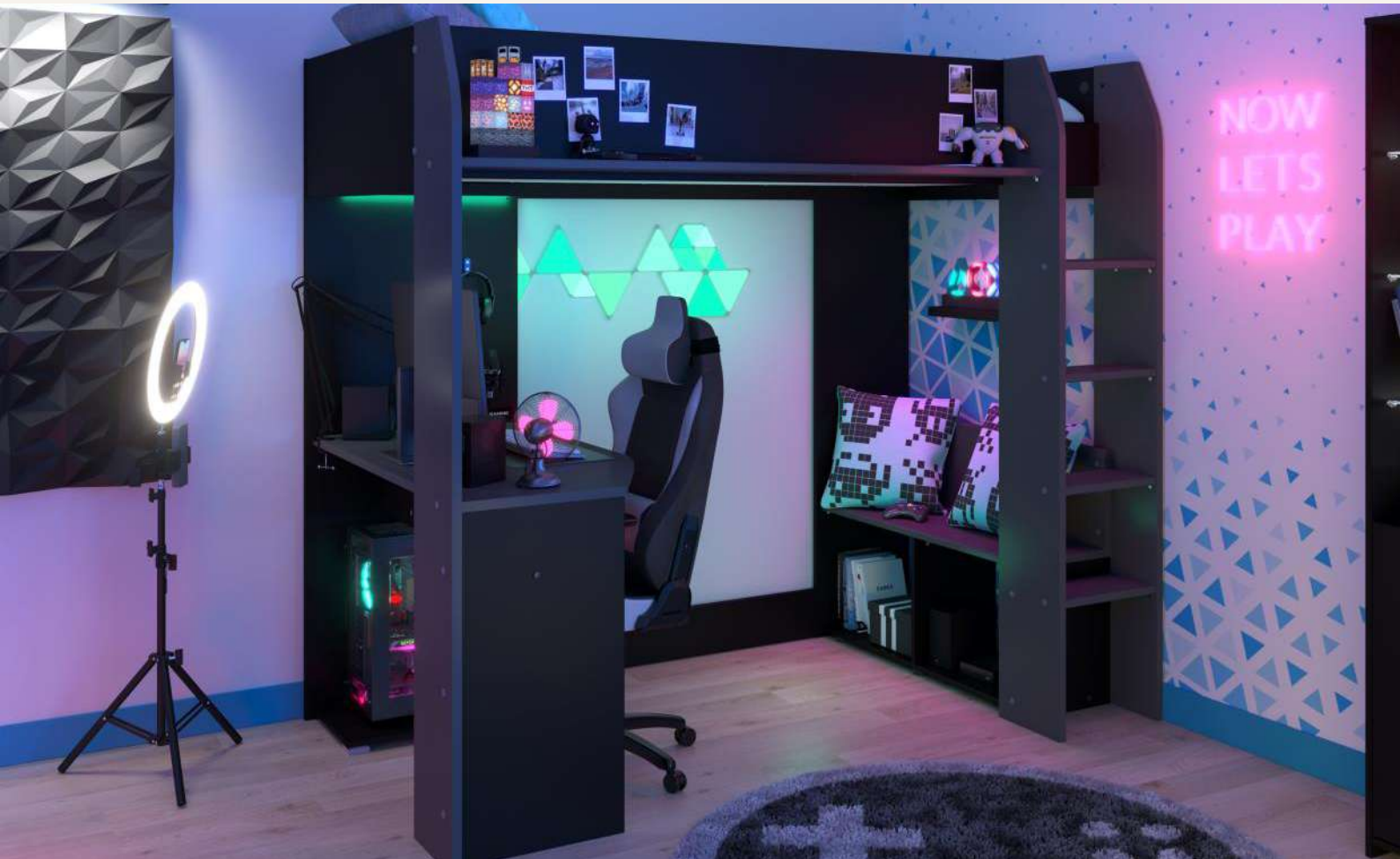

✦ The Legend **90x200** raised bed allows you to **optimize the space** thanks to its desk, its bench, its storage and its bedside shelf all on 2,2m2.

✦ Legend allows you to fully blossom in the Gaming universe. It is designed for the **comfort** of the gamer since he can play on his desk or from his bench, but also store his equipment with a space dedicated to his central unit and headset.

✦ The aesthetic of the Legend raised bed is in adequacy with the Gaming atmosphere, in particular thanks to the **Kit Leds RGB** with remote control and its color **Black Stipple** and **Grey Shade**.



*The products are made of particle board, with a thickness of 15 mm, 18 mm and 22 mm
The drawers are equipped with a metal runner system with rollers*

DARK GEY

BLACK STIPPLE

KID BEDROOM / Legend

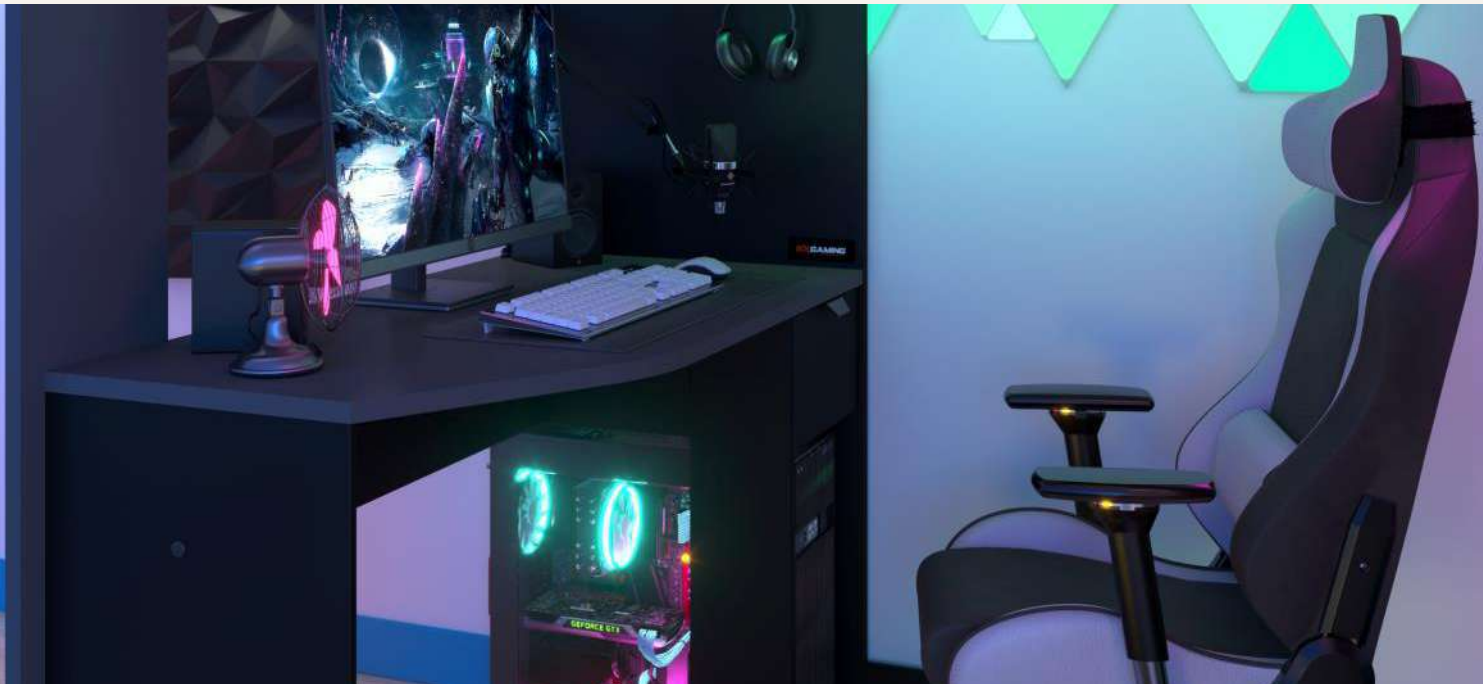

The Gaming **LEGEND** Raised Bed includes:

- Bedding 90x200 cm, bed base included
- A desk 110 x 60cm with a drawer with a handle imitation Carbon, as well as a bench and storage
- A bedside shelf
- Headphone holder
- RGB LED kit with remote control included

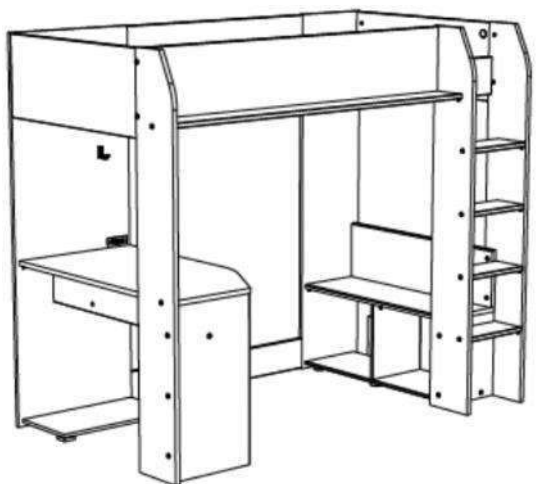

2382LSUR : L204xH180 x P116
Weight : 130 kg - Volume : 0,282m3
Number of packages : 5

KID BEDROOM / LEO



✚ A customisable bunk bed, available in a **Jackson Oak | Shadow Grey** version with Shadow Grey shelves
 or
 in a **White** version with White | Brooklyn Oak or Pink | Blue reversible shelves

✚ A two-level bunk bed including bed bases and **storage compartments** with six L67 x H27 cm shelves, a L207 platform on each floor and an optional drawer on wheels



The products are made of particleboards with a thickness of 15, 18 and 22 mm.
 The optional trundle bed is equipped with a roller runner system.

DARK GREY	PINK	WHITE
JACKSON OAK	BLUE	BROOKLYN OAK

KID BEDROOM / LEO



The LEO customisable bunk bed includes :

- Two 90x200 cm beds, accessible via a three-step ladder
- White | Brooklyn Oak or Pink | Blue reversible shelves delivered with the White version of the LEO bunk bed
- A storage compartment with three L67 x H27 cm shelves and a L207 cm platform on each floor, which can be used as a bedside table
- An optional 163 x 42 cm drawer on wheels

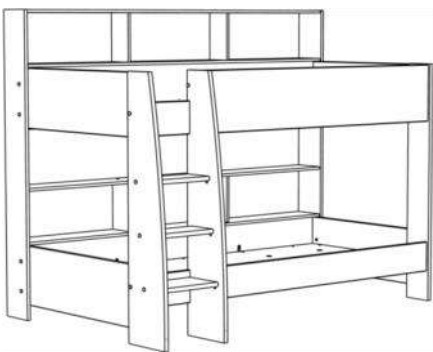

Dimensions : L207 x H164 x D132
 (2344 & 2544) Weight : 130 kg - Volume : 0.274m³
 (2744) Weight : 121 kg - Volume : 0.253m³
 Number of packages : 5

2344LIS4 : White version + Pink | Blue reversible shelves
2544LIS4 : White version + White | Brooklyn Oak reversible shelves
2744LISU : Jackson Oak | Dark Grey version + Dark Grey shelves

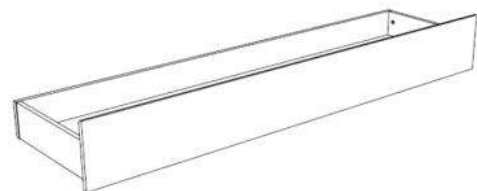

Dimensions : L163 x H22 x D42
 Weight : 10 kg - Volume : 0.022m³

2344TIRO : White version
2744TIRO : Dark Grey version

KID BEDROOM / Lucas



✦ Discover our Lucas midsleeper : the top-of-the-range, multifunctional and complete bed designed to give maximum comfort while optimizing space.

✦ Lucas includes its own workspace with a functional desk that slides under the bed after use. The niches are ideal for storing books. When the desk is closed, the niches align to create a uniform, harmonious front.

✦ To complete the function, a storage space is hidden behind the ladder, contrasting with the work space. Store toys or offer your child a spacious hiding place thanks to the free space under the bed.

✦ A shaped ladder provides access to the bed, with storage shelf and 3 niches as bedside tables. The **Japanese Oak** structural parts recall the robustness of wood, while the **White** elements create an elegant, contemporary two-tone look that will suit boys and girls alike.



The products are made in particleboard, with a thickness of 15 et 22 mm

JAPANESE OAK

WHITE

KID BEDROOM / Lucas



LUCAS midsleeper includes :

- 1 desk with wheel that stores under the bed
- 9 storage niches
- A storage shelf above the niches as bedside tables
- A shaped ladder with 2 steps



2100COMB : L207 x H164 x P132x;
Weight : 123kg - Volume :
0.274m³; Number of packages : 5

KID BEDROOM / Milky



✦ The **Milky** all-in-one bed has plenty of storage spaces including two drawers, a bookcase area, a L100 x D39 cm desk and over **900 liters** of storage space under the

✦ Available in its two modern versions **Jackson Oak | Black Stipple** or **White | Loft Grey** enhancing the lines of this unisex model to make it the central element of both a boy's and girl's room



The products are made of particleboards with a thickness of 15 and 22 mm. The optional trundle bed is equipped with a roller runner system.

WHITE	JACKSON OAK
LOFT GREY	BLACK STIPPLE

KID BEDROOM / Milky



The MILKY all-in-one bed includes :

- A 90x200 cm halfway up bed, adaptable to 90x190 cm, accessible via a two-step ladder
- Two L75 x D35 cm drawers with slim, trendy and ergonomic handles
- A L100 x D39 cm desk
- Over 900 liters of storage space under the bed
- A L75 cm bookshelf space above the drawers as an extension of the desk

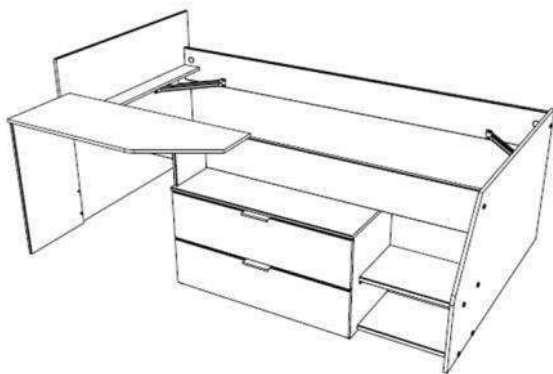

Dimensions : L134 x H90 x D203
Weight : 62 kg - Volume : 0.143m³ (2389) - 0.131m³ (2309)
Number of packages : 2

2389LITI : Jackson Oak | Black Stipple version
2309LITI : White | Loft Grey version

KID BEDROOM / Nashville



✦ Available in three sizes (140x190 cm; 140x200 cm or 90x200 cm), the **Nashville** bed has multiple storage spaces with two drawers and a shelf, which can be placed on the right or left side of the bed according to your wishes

✦ The black metal effect of the handles matches the Black Stipple moulding for a trendy two-tone **Black Stipple | Jackson Oak** look

✦ This model is also available in a more traditional **White | Silver Grey** two-tone look



The products are made of particleboards with a thickness of 15 and 22 mm
The drawers are equipped with a ball-bearing runner system

WHITE	JACKSON OAK
SILVER GREY	BLACK STIPPLE

KID BEDROOM / Nashville



The NASHVILLE bed includes :

- One bed available in 140x190 cm, 140x200 cm or 90x200 cm
- Two L66 x D33 cm removable drawers with slim and trendy black metal effect handles that can be placed on the right or left side of the bed
- A headboard with a Black Stipple molding for the Jackson Oak models or Silver Grey for the White models
- An additional storage space placed between the drawers

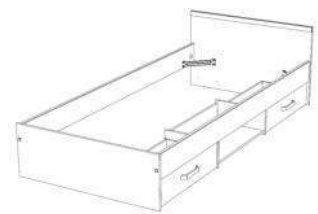

Dimensions : L96 x H59 x D203
Weight : 30 kg - Volume : 0.063m³
Number of packages : 2
2038L2TI : White | Silver Grey version
2078L2TI : Jackson Oak | Black Stipple version

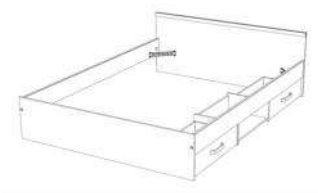

Dimensions : L146 x H59 x D193
Weight : 35 kg - Volume : 0.067m³
Number of packages : 2
2038L14T : White | Silver Grey version
2078L14T : Jackson Oak | Black Stipple version

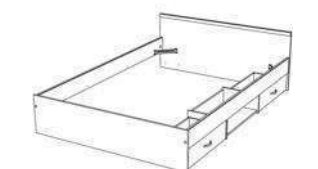

Dimensions : L146 x H59 x D203
Weight : 35 kg - Volume : 0.069m³
Number of packages : 2
2038L24T : White | Silver Grey version



A whole new universe at your fingertips !

✦ In addition to its large desk with a shelf that can accommodate 3 screens, this elevated bed in **Black Stipple** has many assets that will allow you to enjoy an immersive and space-saving experience!

✦ This elevated bed also has many features:

- 90 x 200 cm bed
- large 184 x 60 cm desk
- shelf with double USB socket
- drawer with carbon finish handle
- dedicated space for central unit
- RGB LED kit with remote control



BLACK STIPPLE

The products are made of particleboards with a thickness of 15 and 22 mm
The drawer is equipped with a roller runner system

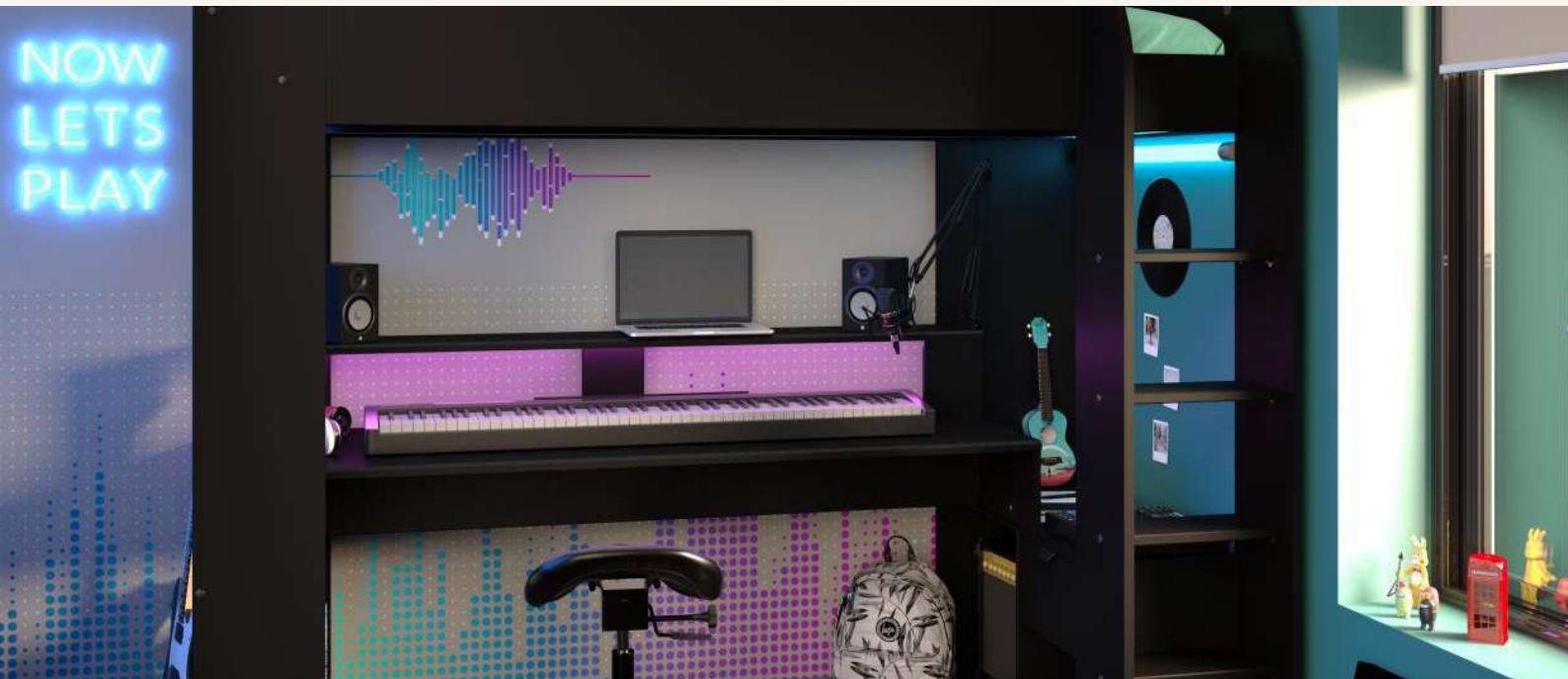

The elevated bed **ONLINE** includes :

- A bed with dimensions of 90x200 cm accessible via a four-step ladder
- A 184 cm long x 60 cm deep desk with a shelf that can accommodate 3 screens
- A bedside platform with double USB socket
- A dedicated space for a central unit, above open storage compartments
- An easily accessible drawer with carbon finish handle
- A RGB LED kit with remote control included
- An additional 90 cm long platform to the left of the desk

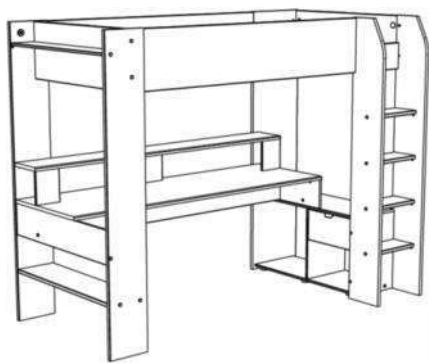

2368LSUR : L220 x H180 x D116
Weight : 133 kg - Volume : 0.275m³
Number of packages : 5

KID BEDROOM / Pirouette



✦ Pirouette is a complete room that will adapt to your child and his needs. This unisex room includes a low bed and a midsleeper, a desk, a bedside table, a chest of drawers and a wardrobe.

✦ Its **White** colour and its reversible panels in **Pebble Grey** or **Pink** can be adapted to your child's taste during assembly. Pirouette is a timeless range that will be the best ally of children and parents.



The products are made of particleboard, with a thickness of 15 mm

WHITE

PEBBLE GREY

PINK

KID BEDROOM / Pirouette



The timeless **PIROUETTE** room includes :

- 2 beds including a 90cm low bed and a misleper with storage and a large rounded desk top.
- A chest with 3 spacious drawers.
- A bedside table with a drawer.
- 1 cupboard of 1.82m with 2 doors and an inside comprising 3 shelves and 2 hanging rails.
- A desk with a door and a niche.



2150COMB : L. : 204 cm - H. : 104 cm - P. 132 ; Weight : 91 ; Volume : 0.187m³ ; Number of packages : 4



2150LI90 : L. : 100 cm - H. : 67 cm - P. : 193 cm ; Weight : 21 ; Volume : 0.055m³ ; Number of packages : 1



2150L290 : L. : 100 cm - H. : 67 cm - P. : 203 cm ; Weight : 21 ; Volume : 0.056m³ ; Number of packages : 1



2150CO3T : L. : 83 cm - H. : 82 cm - P. : 43 cm ; Weight : 26 ; Volume : 0.053m³ ; Number of packages : 1

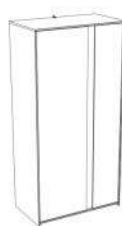

2150AR2P : L. : 91 cm - H. : 182 cm - P. : 50 cm ; Weight : 62 ; Volume : 0.123m³ ; Number of packages : 2



2150BU1P : L. : 110 cm - H. : 75 cm - P. : 50 cm ; Weight : 24 ; Volume : 0.053m³ ; Number of packages : 1



2150CH1T : L. : 33 cm - H. : 40 cm - P. : 33 cm ; Weight : 7 ; Volume : 0.014m³ ; Number of packages : 1

KID BEDROOM / Pirouette



✚ Furnish your boy's or girl's bedroom with our functional and space-saving sleeping solution: the Pirouette mid sleeper !

✚ To store your child's toys or notebooks, Pirouette offers 4 storage niches on which rests a long rounded desk top creating a compact and practical work space. As for your bulky items, they will perfectly find their place in the large space located under the bed where your child will love to hide!

✚ This mid sleeper bed, accessible by 2 steps, stands out thanks to its timeless White colour enhanced by its reversible Pebble Grey or Pink panels.

Its minimalist design and rounded finishes make Pirouette a must-have for mid sleeper beds.



WHITE

PINK

PEBBLE GREY

The products are made of particleboard, with a thickness of 15, 18 and 22 mm

KID BEDROOM / Pirouette



The PIROUETTE combined bed includes:

- A 1m high bed accessible by 2 steps
- A 160cm long desk
- Designed to accommodate a 90x190cm or 90x200cm mattress
- 4 niches of 25cm depth with reversible shelves



2150COMB : L. : 204 cm - H. : 104 cm - P. : 131; weight : 91kg; Volume : 0.187; Number of packages : 4

KID BEDROOM / Reverse



✦ A combined bed at a low price including :

- A 90x200 cm bed, halfway up and accessible via a ladder with two steps
- A removable desk of 89x67 cm
- A storage compartment closed by two doors and a 38 cm deep open storage compartment above

✦ A timeless **White** decoration enhanced by the presence of **Silver Grey** mouldings at the head and foot of the bed for a very contemporary look!



2270COMB : L206 x H110 x D183
 Weight : 101 kg - Volume : 0,212m3
 Number of packages : 2

WHITE

SILVER GREY

The products are made of particleboards with a thickness of 16 and 22 mm

KID BEDROOM / Shelter



✚ Let your imagination run wild and design your room like a tree house with the Shelter collection in Jackson Oak | White tones

✚ A complete bedroom with ten pieces of furniture offering a lot of storage space including various sleeping solutions:

- Two beds of 90x190 cm and 90x200 cm
- A combined bed
- A baby bed



KID BEDROOM / Shelter



The **SHELTER** cabin themed bedroom includes :

- A bed available in 90x190 cm and 90x200 cm with a set of two drawers available as an option
- A 90x200 cm combined-bed
- A wardrobe with 2 doors and a drawer
- A desk with drawer
- A two-drawer chest of drawers with two storage compartments
- An environment that can be arranged around the bed or the desk
- A bedside table with one door
- A baby bed and a changing table

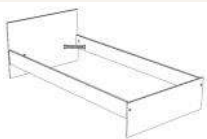

2400L190 : L98 x H66 x D194 | Weight : 20 kg - Volume : 0,043m³ | Number of packages : 2

2400L290 : L98 x H66 x D203 | Weight : 21 kg - Volume : 0,047m³ | Number of packages : 2



2400ENVI : L132 x H152 x D32

Weight : 43 kg - Volume : 0,094m³

Number of packages : 2



2400A2PT : L92 x H182 x D50

Weight : 61 kg - Volume : 0,127m³

Number of packages : 2



2400COMB : L204 x H120 x D114

Weight : 90 kg - Volume : 0,170m³

Number of packages : 4



2400CH1P : L40 x H42 x D33

Weight : 7 kg - Volume : 0,019m³



2400LIBB : L124 x H86 x D66

Weight : 22 kg - Volume : 0,096m³

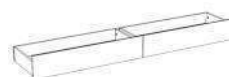

2400TIRO : L189 x H21 x D42

Weight : 12 kg - Volume : 0,024m³



2400CO2T : L84 x H78 x D40

Weight : 26 kg - Volume : 0,056m³



2400BURE : L94 x H71 x D50

Weight : 16 kg - Volume : 0,037m³



2400PLAN : L55 x H20 x D77

Weight : 7 kg - Volume : 0,018m³

KID BEDROOM / Shelter



✦ Discover in our cabin style range the Shelter midsleeper.

✦ Its 90x200 bed accessible by 2 steps has storage space thanks to its niches, ideal for storing your child's notebooks, folders or toys. It also has a desk on wheels that can be easily moved. Under the bed, you can store your bulky items while optimising space.

✦ The Shelter midsleeper bed will perfectly match the other elements of the range, creating a unique universe for girls and boys thanks to its natural and mixed **White** and **Jackson Oak** colours.



The products are made un particule boards with a thickness of 15 and 22mm
The drawers are equipped with a roller runner system (ball bearing for the office and the environment)

JACKSON OAK

WHITE

KID BEDROOM / Shelter



SHELTER midsleeper includes :

- A 90x200cm bed
- A desk on wheels
- A scale with 2 steps
- 1 shelf

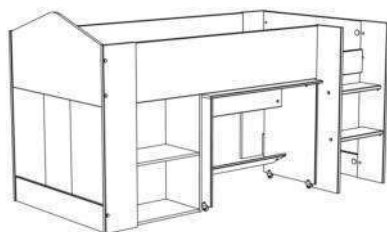

2400COMB : L204 x H120 x P114

Weight : 90 kg - Volume : 0,170m³

Number of packages : 4

KID BEDROOM / Shelter



✦ The Shelter range is extending with its bunkbed !

✦ A space-saving bunkbed including a base, niches and shelves are a great feature acting as the equivalent of a bedside table. Its rounded ladder guarantees easy and safe access to the top bunk.

✦ An optional large storage drawer can be added to optimise the space under the bed.

✦ The Shelter bunkbed will perfectly fit with the other items of the range, creating a unique universe for girls and boys with its natural White and Jackson Oak colours.



JACKSON OAK

WHITE

The products are made in particle board with a thickness of 15 and 22 mm

The drawers are equipped with a roller runner system

KID BEDROOM / Shelter



SHELTER bunked includes :

- Two 90x200 cm beds
- A ladder with 3 steps
- 1 base, 3 niches and shelves acting as the equivalent of a bedside table
- L163xP42cm drawer in option



2400LISU : L207 x H164 x P132
Weight : 121 kg - Volume : 0,253m³
Number of packages : 5



2400TIR2 : L163 x H22 x P42
Weight : 10 kg - Volume : 0,022m³
Number of packages : 1

KID BEDROOM / Sleep



- ✦ The compact, design Sleep day bed has been updated with new, trendy, mixed colours !
- ✦ No need of bedside table, thanks to its 3 niches and 2m of storage shelf, so you can keep everything within easy reach. To optimise storage without requiring more space in your bedroom, add our option of 2 large drawers under your bed, available in two colours.

✦ During assembly, Sleep will adapt to your tastes by offering you **White** or **Japanese Oak** niche back panels. The colours of this modern bed with its rounded shapes will look just as good in a girl bedroom as in a boy bedroom.



WHITE

JAPANESE OAK

The products are made in particleboard with a thickness of 15 mm.

KID BEDROOM / Sleep



The **SLEEP** day bed includes :

- A 90x190-200 cm bed
- 3 storage niches with either White or Oak back panels
- Set of 2 drawers available in two colours

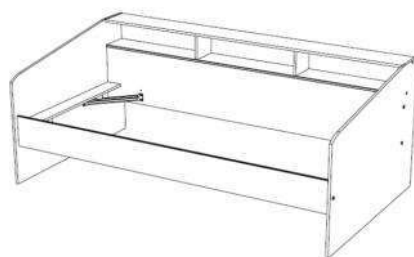

2339L290 : L203 x H82 x P113.
Weight : 48 kg - Volume : 0.104m³
Number of packages : 2

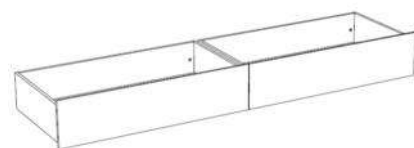

L199 x H25 x P53. Weight : 18 kg -
Volume : 0.041m³; Number of
packages : 1

2339TIRO : Japanese Oak
2338TIRO : White

KID BEDROOM / Smoozy



✚ A complete and **functional** bedroom offering two different sleeping solutions at a low price: a low bed equipped with **large drawers** to store books, toys and much more, or an elevated bed including a desk with a large surface and 3 side shelves

✚ This **Petterson Pine** decor bedroom is equipped with beautiful and ergonomic recessed handles but also with reversible **Blue | Pink** edges for a look that will appeal to both girls and boys!



The products are made of particleboards with a thickness of 15 and 22 mm

The drawers are equipped with a roller runner system (or with a ball-bearing one for the bedside table and the desk)

PETTERSON PINE

BLUE

PINK

KID BEDROOM / Smoozy



The **SMOOZY** bedroom includes :

- A functional bed with two drawers and two storage compartments
- An elevated bed including a desk with a 160 cm long top and 3 side shelves
- A bedside table with a drawer
- A chest of drawers composed of 3 drawers
- A desk with a drawer and a door
- A 182 cm high wardrobe, equipped with 3 shelves and 2 hanging bars



2223L2TI : L95 x H80 x D203
Weight : 52 kg - Volume : 0,106m³
Number of packages : 2



2223LSUR : L206 x H180 x D108
Weight : 111 kg - Volume : 0,226m³
Number of packages : 3



2223BURE : L121 x H77 x D50
Weight : 28 kg - Volume : 0,07m³



2223CH1T : L40 x H41 x D33
Weight : 8 kg - Volume : 0,018m³



2223CO3T : L79 x H75 x D41
Weight : 28 kg - Volume : 0,056m³

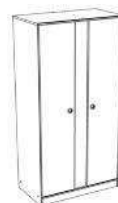

2223A2PR : L90 x H182 x D51
Weight : 63 kg - Volume : 0,129m³
Number of packages : 2

KID BEDROOM / Snoop



Organise your space according to your needs!

✦ Clever and ingenious, the Snoop bedroom consists of a beautiful **White** bed equipped with two large drawers to which you can also add one to three **modular environments**

✦ The modular environment is equipped with sliding doors that can be positioned either at the middle or the top of it

✦ The sleeping area of 90x200 cm can be adapted to 90x190 cm



The products are made of particleboards with a thickness of 15 and 22 mm
The drawers are equipped with a ball bearing runner system

WHITE



The SNOOP range includes

- A bed with a 90x200 or 90x190 mattress
- 2 drawers
- An environment with sliding doors that can be positioned in the middle or on top.
- The bed can be combined from 1 to 3 environments



2572L2TI : L98 x H67 x D203

Weight : 31 kg - Volume : 0,069m3

Number of packages : 2



2572ENVI : L98 x H108 x D28

Weight : 20 kg - Volume : 0,045m3

KID BEDROOM / Stim 2



✦ A bunk bed with two more distinct sleeping spaces than a conventional bunk bed

✦ A shaped ladder that allows easy and safe access to the top bed

✦ An integrated two-level layout with a closed storage space including a three-ray shelf, a wardrobe rail, a drawer, a platform of L92 x D16 cm next to the upper bed + a bedside table of L57 x D24 cm behind the lower storage space



The products are made of particleboards with a thickness of 15 and 22 mm
The drawer is equipped with a roller runner system

DARK GREY

JACKSON OAK



The **STIM 2** bunk bed includes :

- Two bunk beds of 90x200 cm, with bed bases and accessible via a three-step ladder
- One L104 x D39 cm drawer below the bottom bed
- A L57 x D24 cm bedside table behind the lower storage compartment
- A closed storage compartment including a L72 x D37 cm three-level shelf
- A wardrobe rail behind the closed storage compartment, with an integrated shelf
- A platform of L92 x D16 cm at the edge of the upper bed

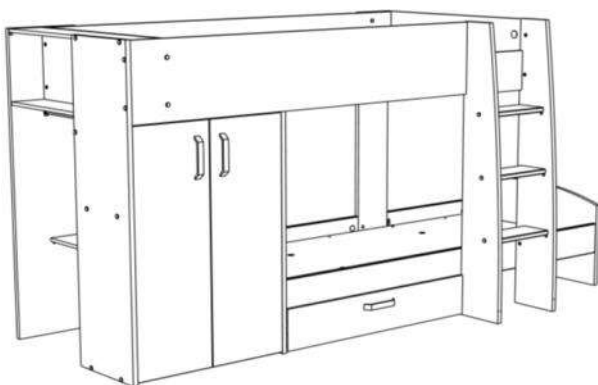

2142LISU : L280 x H142 x D119
Weight : 150 kg - Volume : 0.299m3
Number of packages : 5

KID BEDROOM / Tobo



✦ **Playful and functional**, this half-height bed has extra storage space under the bed with two side drawers equipped with ergonomic handles and an open shelf at the bottom of the bed

✦ The slide ramp is adapted to children and protected by ABS edges to guarantee their safety

✦ A trendy and refined style with the two-tone **White | Jackson Oak** decor that brings a touch of nature



The products are made of particleboards with a thickness of 15 and 22 mm
The drawers are equipped with a roller runner system

WHITE

JACKSON OAK



The TOBO bed-toboggan includes :

- A bed sized 90x200 cm, halfway up, including a bed base and accessible via a two-step ladder
- Two L64 x D35 cm drawers with ergonomic handles
- Two storage spaces of L90 x W30 cm at the bottom of the bed
- A toboggan sized L97 x W35 cm

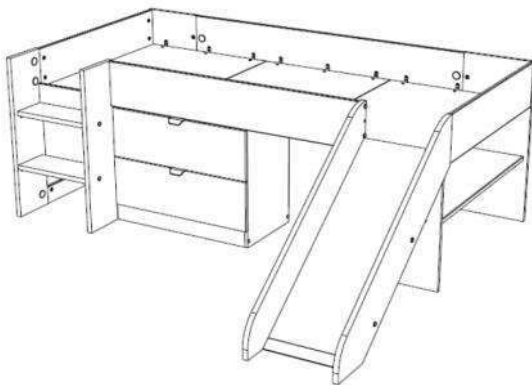

2374TOBO : L204 x H78 x D184
Weight : 83 kg - Volume : 0.185m3
Number of Packages : 3

KID BEDROOM / TOM



✚ A multi-functional combined bed with a sleeping area, a 130 cm long desk with cable management, large storage spaces and a spacious wardrobe

✚ Create a natural and warm atmosphere in your child's room with this **Jackson Oak | White** bed

✚ Easy access to the bed thanks to a shaped passageway and a wide, refocused ladder



The products are made of particleboards with a thickness of 15 and 22 mm
The drawers are equipped with a ball-bearing runner system

JACKSON OAK

WHITE

KID BEDROOM / TOM



The combined bed **TOM** includes :

- A 90x200 cm sleeping area accessible via a four-step ladder
- A large 130 cm long desk with cable management, but also 3 deep drawers for maximum storage capacity
- A spacious closed cupboard-type storage space measuring over 65 cm long x 106 cm high x 40 cm deep and including a shelf and a hanging bar

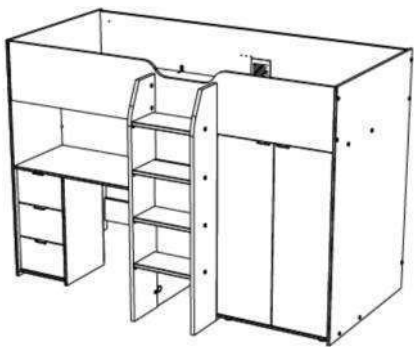

2360COMB : L203 x H146 x D118
Weight : 135 kg - Volume : 0.285m³
Number of packages : 5



ADULT BEDROOMS

ADULT BEDROOM / Aalborg



✦ The Aalborg collection is inspired by the **Nordic** style with its pure lines and compass legs. We also appreciate the **White | Japanese Oak** and **Black Stipple | Japanese Oak** colour combinations

✦ Slim handles subtly dress up the furniture for an elegant and timeless look

✦ Beautiful 84-cm-high headboards are included with the beds which are available in 140x190 cm, 140x200 cm or 160x200 cm



The products are made of particleboards with a thickness of 12, 15 and 22 mm

The drawers are equipped with a roller runner system (a ball bearing one for the bedside table)

JAPANESE OAK

JAPANESE OAK

WHITE

BLACK STIPPLE

ADULT BEDROOM / Aalborg



The Nordic-inspired bedroom **AALBORG** includes :

- A bed available in 140x190 cm, in 140x200 cm or in 160x200 cm including a H84 cm headboard
- A 56 cm high bedside table with a drawer and an open storage compartment
- A chest of drawers with three 40-cm-deep drawers
- A 3-door wardrobe equipped with 3 shelves, one hanging bar and two drawers with hand grip

Dimensions : L145 x H84 x D195

Weight : 36 kg - Volume : 0,073m³

Number of packages : 3

3500L140 : White | Japanese Oak version

3501L140 : Black Stipple | Japanese Oak version



Dimensions : L165 x H84 x D205

Weight : 42 kg - Volume : 0,084m³

Number of packages : 4

3500L260 : White | Japanese Oak version

3501L260 : Black Stipple | Japanese Oak version



Dimensions : L145 x H84 x D205

Weight : 36 kg - Volume : 0,074m³

Number of packages : 3

3500L240 : White | Japanese Oak version

3501L240 : Black Stipple | Japanese Oak version



Dimensions : L135 x H200 x D54

Weight : 93 kg - Volume : 0,18m³

Number of packages : 3

3500AR3P : White | Japanese Oak version

3501AR3P : Black Stipple | Japanese Oak version

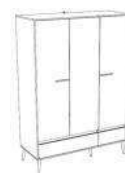

Dimensions : L44 x H56 x D33

Weight : 8 kg - Volume : 0,019m³

3500CH1T : White | Japanese Oak version

3501CH1T : Black Stipple | Japanese Oak version



Dimensions : L91 x H78 x D40

Weight : 26 kg - Volume : 0,058m³

3500CO3T : White | Japanese Oak version

3501CO3T : Black Stipple | Japanese Oak version



ADULT BEDROOM / Bianca



✚ Equipped with a head and foot-board in glossy white finish, this very contemporary model will allow you to give your room a modern look at a low price

✚ A bedside table with an 11 cm high **Glossy White** drawer is also available to complete your set-up

✚ A sober and natural style with **Matte White** and **Glossy White** finishes

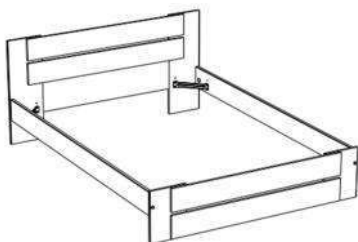

3071L140 : L146 x H75 x D195
Weight : 26 kg - Volume : 0,050m³

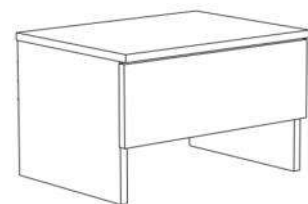

3071CHET : L44 x H29 x D33
Weight : 6 kg - Volume : 0,013m³

ADULT BEDROOM / Bridge



➤ Bridge is a complete, contemporary and space-saving bedroom that will allow you to integrate storage units, bedside tables, a wardrobe and shelves.

➤ The bed fits perfectly onto the headboard whose decorative black niche is illuminated by LEDs, giving your wall a modern touch while offering contrast.

➤ The headboard, thanks to its shallow depth, guarantees a small space requirement while freeing space for the bed.

➤ Bridge is available in two versions: **Brooklyn Oak** and **Black Stipple**, with its industrial loft style, and **Brooklyn Oak** and **Shiny White**, with its contemporary, natural Vintage look.



The products are made of chipboard, with a thickness of 15 mm

BROOKLYN OAK

BROOKLYN OAK

BLACK STIPPLE

SHINY WHITE



The Loft **BRIDGE** bed and headboard include :

- One 5-door headboard with an interior layout combining : 6 shelves, 1 retractable hanging rail, 5 niches, 2 retractable bedside shelves and LEDs with remote control
- 1 bed available in 2 sizes: 140 x 190 cm and 160 x 200 cm
- 1 bed drawer option which is adaptable to both 190 and 200 cm beds dimensions.



L: 2652 x H.: 2028 x P. : 398 mm ; Weight : 126; Volume : 0.243 ; Number of packages : 4

3130ENVI : Oak / Black Stipple
3230ENVI : Oak / Shiny White



3130L140 : L: 1674 x H.: 829 x P. : 1936 mm ; Weight : 33 ; Volume : 0.096 ; Number of packages: 1



3130TIRO : L:2000 x H.: 219 x P. : 507 mm ; Weight : 14 ; Volume : 0.029 ; Number of packages : 1

3130TIRO : Oak / Black Stipple
3230TIRO : Oak / Shiny White



3130L260 : L: 1674 x H.: 829 x P. : 2036 ; Weight : 35 ; Volume : 0.101 ; Number of packages : 1

ADULT BEDROOM / Ekko



✦ A **complete range** including a bed, a headboard with 4 side storage compartments, a bedside table with one drawer, a 6-drawer chest of drawers, a 3-door wardrobe and a curtain wardrobe

✦ Ideal for fitting out small spaces

✦ Additional storage with optional under-bed drawers available in option

✦ A **trendy style** thanks to the Brooklyn Oak color that brings a touch of calm and nature



*The products are made of chipboard, with a thickness of 15mm
The drawers are equipped with a ball bearing runner system*

BROOKLYN OAK



The trendy **EKKO** bedroom includes :

- One bed available in 140x190 cm or 160x200 cm with the possibility of adding drawers on option
- A 3-door wardrobe + A second curtain wardrobe with 4 drawers
- A chest of drawers with 6 drawers
- A headboard with 4 lateral storage compartments and an other storage space with 2 sliding doors above
- A bedside table with 1 drawer



3782L140 : L150 x H71 x D193
Weight : 25 kg - Volume : 0,050m3



3782TIRO : L189 x H22 x D51
Weight : 13 kg - Volume : 0,029m3



3782L260 : L170 x H71 x D206
Weight : 30 kg - Volume : 0,076m3



3782ENVI : L170 x H101x D32
Weight : 29 kg - Volume : 0,061m3



3782RANG : L153 x H203 x D57
Weight : 87 kg - Volume : 0,176m3
Number of packages : 3



3782CHEV : L40 x H41 x D33
Weight : 8 kg - Volume : 0,017m3

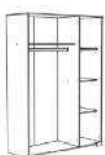

3782AR3P : L139 x H197 x D52
Weight : 94 kg - Volume : 0,179m3
Number of packages : 3



3782CO6T : L121 x H81 x D41
Weight : 43 kg - Volume : 0,087m3
Number of packages : 2

ADULT BEDROOM / Escale



✦ Escale, an adult bedroom with a chic, natural style, includes hand-grip handles and discreet decorative mouldings.

✦ Discover the Escale bed, now available in 140 and 160cm! Its removable bedside shelves let you personalise your headboard, thanks to its reversible Oak and White colour. Add drawers to optimise storage

✦ Escale offers a 3-door wardrobe with inside mirror and a reversible **Oak** or **White** vertical panel. Spacious, it will adapt to your needs thanks to its two hanging rails and 3 shelves. Complete your storage space with its harmonious 1-door 3-drawer chest.

✦ Inspired by the Japandi trend, this range in **Japanese Oak** colour is ideal for a relaxing, natural atmosphere.



The products are made of particleboard 15 and 22 mm thickness.

Chest drawers are equipped with a roller runner system

JAPANESE OAK

ADULT BEDROOM / Escale



The ESCALE nature inspired room includes :

- 140x190-200 and 160x200cm beds with headboard with reversible shelves in white and Japanese oak that serve as a bedside table.
- Optional set of two 51 cm-deep drawers
- A chest with a door and 3 drawers
- A 3-door wardrobe including 1/3 shelving part (3 shelves) and 2/3 hanging part and inside mirror.



3580L240: L203 x H98 x P217;
Weight : 56 kg - Volume : 0,119m3;
Number of packages : 2



3580L260 : L223 x H98 x P217;
Weight : 59 kg - Volume : 0,133m3;
Nombre de colis : 3

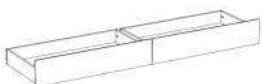

3580T2RO : L199 x H22 x P51;
Weight : 13 kg - Volume : 0,031m3,
Number of packages : 1

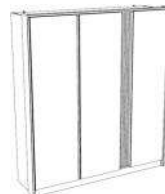

3580AR3P : L185 x H203 x P52
Weight : 130 kg - Volume : 0,275m3
Number of packages : 4



3580COPT : L110 x H77 x P50
Weight : 42 kg - Volume : 0,084m3
Number of packages : 2

ADULT BEDROOM / Evo II



✦ An adult bedroom with all the essential bedroom furniture and two beds of different sizes at a **small price!**

✦ This bedroom in **Silver Walnut** decor is equipped with beautiful **Aluminium Grey** handles, forming an elegant colour combination!



SILVER WALNUT

The products are made of particleboards with a thickness of 15 mm

The drawers are equipped with a roller runner system (chest of drawers) or with a ball one (bedside table)

ADULT BEDROOM / Evo II



The bedroom **EVO II** includes :

- 140x190cm bed , with decorative headboard with a height of 72 cm
- A 3-door wardrobe with a large central mirror
- A bedside table with drawer
- A chest of drawers with 3 drawers



3778L140 : L147 x H72 x D194
Weight : 23 kg - Volume : 0,05m3



3778AR3P : L139 x H197 x D52
Weight : 93 kg - Volume : 0,177m3
Number of packages : 2



3778CO3T : L76 x H88 x D44
Weight : 31 kg - Volume : 0,064m3



3778CHEV : L44 x H35 x D33
Weight : 7 kg - Volume : 0,016m3

ADULT BEDROOM / Lodge



✦ Lodge offers you functions and aesthetics with its adult bed and spacious headboard.

✦ The headboard has 4 storage niches and a large table top. The bed has a set of two drawers and a storage niche that can be positioned on the left or right side during assembly

✦ Available in two versions, Lodge adapts to your taste and style. Choose the elegant and sober two-tone **Brooklyn Oak** and **Black Stipple**, or the bright and warm **Brooklyn Oak** and **Home White** version.



The products are made of particle board, with a thickness of 15mm

The drawers are equipped with a roller runner system

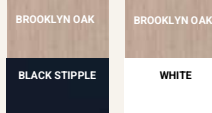



The functional and aesthetic LODGE bed includes :

- 4 side niches on the headboard
- 2 drawers adaptable to the left or right side
- A storage niche

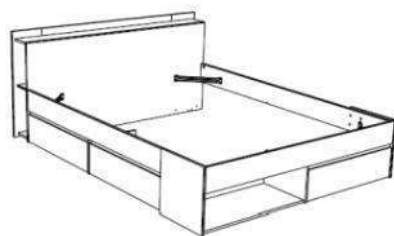

Dimensions : L148 x H70 x P212

Weight : 47 kg - Volume : 0,094m³

Nombre of packages : 2

3783L140 : Oak | Black Stipple

3785L140 : Oak | White

ADULT BEDROOM / Morpheus



✦ The **Morpheus** headboard allows you to decorate your 140 or 160 cm bed base with numerous storage spaces. Its 3 open compartments and 2 bedside cabinets located on either side of the bed will give you the opportunity to combine storage while enhancing your sleeping space.

✦ In an industrial style, the headboard brings to your interior a chic and trendy design thanks to the contrasting colors **Black Stipple** and **Chene Artisan**. Our aesthetic and functional headboard will offer your bedroom modernity and elegance.

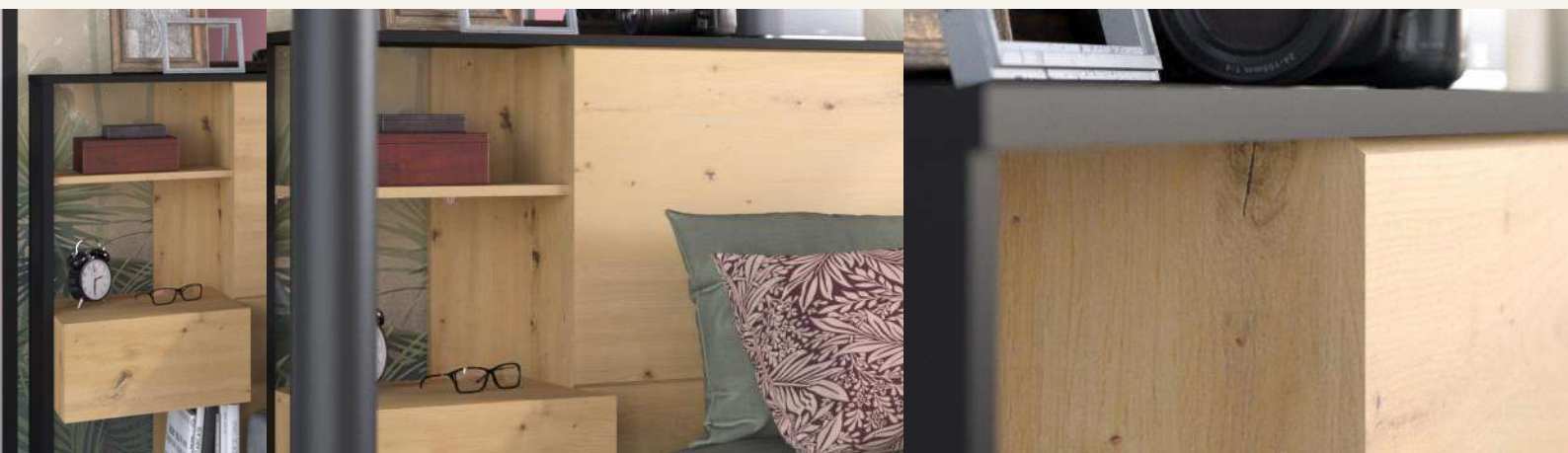

The products are made of particle board, with a thickness of 15 mm

The drawers are equipped with a metal runner system with rollers + shock absorbers

ARTISAN OAK

BLACK STIPPLE

ADULT BEDROOM / Morpheus



The functional and industrial **MORPHEUS** headboard includes:

- A place for a bed of 140 or 160 cm width
- Two bedside cabinets equipped with drawers with roller runners with a depth of 33 cm
- 6 storage niches with a useful depth of 19 and 21 cm

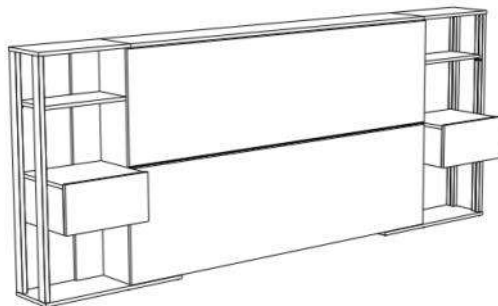

3170TETE : L253 x H103 x P36

Weight : 50 kg - Volume : 0.099m³

Number of packages : 2



✦ A functional bed with three L75 x D35 cm drawers with two of them reversible (can be assembled on the right or left hand side of the bed) and a headboard including 4 side storage compartments + a 15-cm-deep platform

✦ A natural style available in three different two-tone colours : **White | Light Acacia or White | Silver Walnut et Black Stipple | Jackson Oak .**

✦ The L240 bed version is adaptable to 140x190 cm or 140x200 cm mattress size



*The products are made of particleboards with a thickness of 15 and 22 mm
The drawers are equipped with a roller runner system*

JACKSON OAK	LIGHT ACACIA	SILVER WALNUT
BLACK STIPPLE	WHITE	WHITE



The **MOST** bed includes :

- A sleeping dimension of 140x190 cm, 140x200 cm or 160x200 cm
- Three L75 x D35 cm drawers, two of them can be assembled on the right or left hand side of the bed
- An open storage compartment at the foot of the bed, next to the third drawer
- The headboard includes 4 lateral storage compartments with a space for cables + a 15 cm deep platform on the top of the headboard

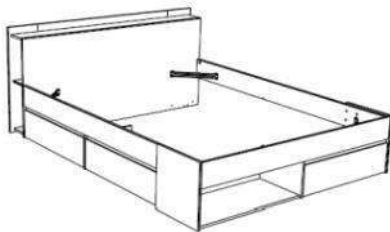

Dimensions : L150 x H79 x P220

Poids : 60 kg - Volume : 0,126m3

Nombre de colis : 2

1330L240 : White | Silver Walnut

1530L240 : White | Light Acacia

1630L240 : Black Stipple | Jackson Oak

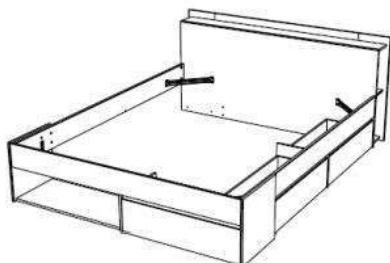

Dimensions : L170 x H79 x P220

Poids : 64 kg - Volume : 0,129m3

Nombre de colis : 3

1330L260 : White | Silver Walnut

1530L260 : White | Light Acacia

1630L260 : Black Stipple | Jackson Oak

KID BEDROOM / Nashville



✦ Available in three sizes (90x200, 140x190 cm, 140x200 cm and now in 160x200cm), the **Nashville** bed has multiple storage spaces with two drawers and a shelf, which can be placed on the right or left side of the bed according to your wishes

✦ The black metal effect of the handles matches the Black Stipple moulding for a trendy two-tone **Black Stipple** | **Jackson Oak** look

✦ This model is also available in a more traditional **White** | **Silver Grey** two-tone look



*The products are made of particleboards with a thickness of 15 and 22 mm
The drawers are equipped with a ball-bearing runner system*

WHITE	JACKSON OAK
SILVER GREY	BLACK STIPPLE

KID BEDROOM / Nashville



The **NASHVILLE** bed includes :

- One bed available in 90x200, 140x190 cm, 140x200 cm and now in 160x200cm
- Two L66 x D33 cm removable drawers with slim and trendy black metal effect handles that can be placed on the right or left side of the bed
- A headboard with a Black Stipple molding for the Jackson Oak models or Silver Grey for the White models
- An additional storage space placed between the drawers

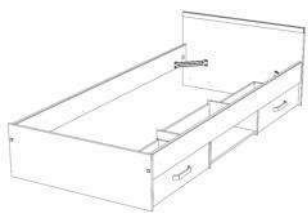

Dimensions : L96 x H59 x D203
 Weight : 30 kg - Volume : 0.063m³
 Number of packages : 2
2038L2T1 : White | Silver Grey version



Dimensions : L146 x H59 x D203
 Weight: 35 kg - Volume : 0.069m³
 Number of packages : 2
2038L24T : White | Silver Grey version



Dimensions : L146 x H59 x D193
 Weight : 35 kg - Volume : 0.067m³
 Number of packages : 2
2038L14T : White | Silver Grey version
2078L14T: Jackson Oak | Black Stipple version

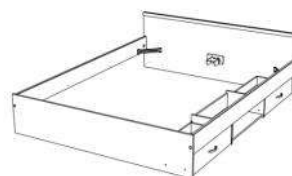

Dimensions : L166 x H59 x D203
 Weight: 39 kg - Volume : 0.078m³
 Number of packages : 3
2038L26T: White | Silver Grey version

ADULT BEDROOM / Orion



✚ The clever and functional Orion headboard can be used as a bedside table thanks to its black or white side niches. You can put your books or decorations there to embellish your bedroom.

✚ The Orion headboard can accommodate the Stamp bed range to give it a stronger look.

✚ Orion is designed to allow you to fix Leds to illuminate the niches.

✚ This piece of furniture in **Artisan Oak / Black Stipple** or **Artisan Oak / Home White** is as aesthetic as it is clever. It will dress your wall and decorate your room in an industrial or natural style, cosy and warm.

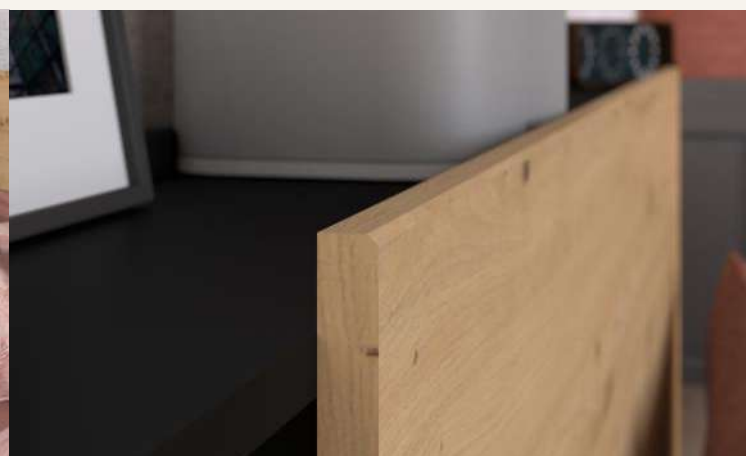

The products are made of chipboard, with a thickness of 15 mm

ARTISAN OAK

ARTISAN OAK

BLACK STIPPLE

WHITE



The **ORION** design headboard includes :

- One 222 cm long and 1m high headboard .
- 6 side niches.
- Can accommodate the Stamp bed.
- 2 colours Artisan Oak / Black Stipple or Artisan Oak / Home White

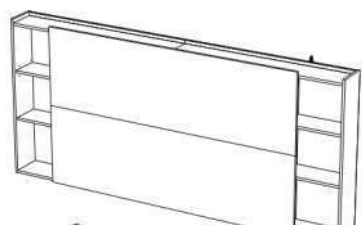

L: 222 x H.: 100 x P. : 23 cm

3101TETE : Black Stipple

3102TETE : Blanc Home

ADULT BEDROOM / Santorin



✦ Elegant and sophisticated, the Santorin headboard combines functions and style with clean lines and nice contrasting colours.

✦ Space saving, Santorin includes 4 storage units with doors whose opening is designed to be easily accessible. Its bedside tables with drawers create relief and allow you to keep your essentials within easy reach.

✦ This headboard stands out thanks to its half-height which optimises space around your 160 or 140cm bed base. Its very trendy two-tone **Brooklyn Oak** and **Black Stipple** gives it a chic and assertive look making it a strong piece of furniture. Discover the natural version, with its fresh, modern look in a warm, luminous two-tone of **Brooklyn Oak** and **Shiny White**.



The products are made of particle board, 15 mm thickness

The drawers are equipped with a metal ball bearing runner system for the bedside

BROOKLYN OAK

BROOKLYN OAK

SHINY WHITE

BLACK STIPPLE



The SANTORIN half-height headboard includes :

- A 150cm high headboard
- 4 storage units with hinged doors
- Possibility of adding an LED strip in the decorative niche
- 2 hanging bedside cabinets with drawer
- Can be use with the BRIDGE range 140 or 160cm

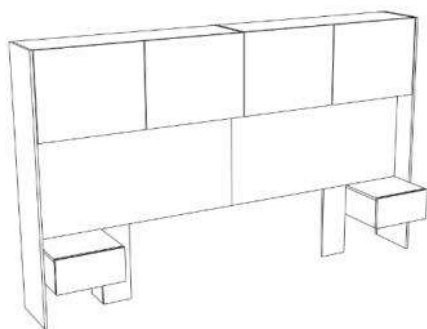

L: 2458 x H: 1500 x P : 508 mm; Weight : 72 ;
Volume : 0,142 ; Number of packages : 3

3180TETE : Brooklyn Oak / Black Stipple

3181TETE : Brooklyn Oak / Shiny White

ADULT BEDROOM / Soluce



✦ Rediscover the essential Soluce bed, clean and elegant, now available in 2 sizes: 140x190 and 160x200!

✦ With a headboard including a trendy aluminum gray line, this elegant model will seduce you with its sleek style and excellent value for money

✦ Fresh and bright, the Matte White colour of Soluce beds is clean and contemporary. Don't be afraid to change the decoration of your room, your bed will adapt to all your customizations with its timeless colour. Soluce is a safe bet that will perfectly suit an adult or a teenager!



The products are made of particled board, with a thickness of 15 mm

WHITE



SOLUCE timeless beds include :

- A headboard with an aluminum line
- A clean and timeless matte white colour
- 2 dimensions: a bed 140x190cm and now 160x200 cm

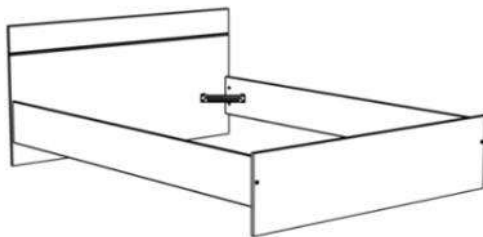

3023L140 : L145 x H75 x P193

Weight : 27 kg - Volume :
0,066m³; Number of packages : 1

3023L260 : L165 x H75 x P204

Weight : 30 kg - Volume :
0,068m³; Number of packages : 1

ADULT BEDROOM / Stamp



➤ Designed to fit a 140 or 160 cm wide bed base, the STAMP headboard has **multiple storage compartments** including 3 shelves on each side of the bed, as well as two bedside tables with one drawer each

➤ Scandinavian-inspired with its minimalist design and two-tone look in **White Home | Artisan Oak**, the STAMP headboard is ideal for creating a cosy, bright and welcoming place to sleep



The products are made of particleboards with a thickness of 15 mm
The drawers are equipped with a roller runner system + shock absorbers

ARTISAN OAK

WHITE



The functional and minimalist **STAMP** headboard includes :

- One slot for a 140 or 160 cm wide bed
- 6 storage shelves, with a depth of 18 and 33 cm
- Two 29 cm deep bedside tables with one drawer each equipped with roller runners and shock absorbers

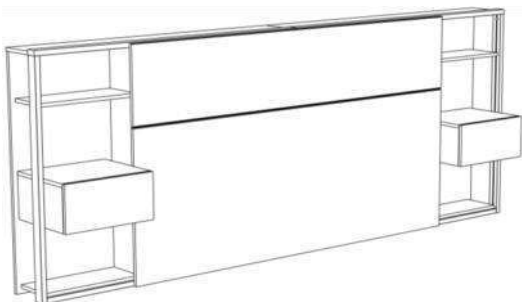

3199TETE : L255 x H103 x D36

Weight : 55 kg - Volume : 0.122m³

Number of packages : 2

ADULT BEDROOM / Stamp



➤ Designed to accommodate a 160 x 200 bed base, the **Stamp** bed frame will perfectly combine with the headboard of the same name and the **Orion** headboard.

➤ The bed frame has a niche at the front and optional drawers can be added on either side to maximise storage space.

➤ Scandinavian-inspired with the two-tone **Artisan Oak | Home White** or industrial with the two-tone **Artisan | Black Stipple** and minimalist design, **STAMP** is ideal for creating a cosy, bright and welcoming nest.



The products are made of particleboards, with a thickness of 15 and 18 mm
The drawers are equipped with a roller runner system with rollers + shock absorbers

ARTISAN OAK

BLACK STIPPLE

WHITE

ADULT BEDROOM / Stamp



The functional and minimalist **STAMP** bed frame includes:

- A bed frame that can accommodate a 160 x 200cm bed base.
- 1 storage niche.
- 1 drawer option of 175 x 51 cm with metal handles

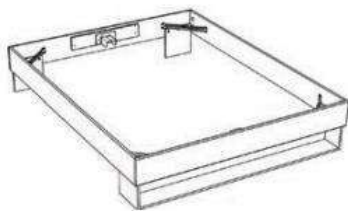

L260 L: 206 x H.: 38 x P. : 164 cm
160 x 200 cm mattress
3122L260 : Artisan Oak / White Home
3121L260 : Artisan Oak / Steam Black



TIRO L: 175 x H.: 18 x P. : 51 cm
3121TIRO : Black
3122TIRO : Artisan Oak

ADULT BEDROOM / Toronto



✚ A complete and cosy adult bedroom with large storage capacity and two beds

✚ An industrial look of character with the combination of **Authentic Oak** - **Steam Black** decors accentuated by the metallic aspect of the furniture frames



The products are made of particleboards with a thickness of 15 and 18 mm

The drawers are equipped with a roller runner system

AUTHENTIC OAK

STEAM BLACK



The bedroom TORONTO includes :

- Two beds with dimensions of 140x190 cm and 160x200 cm, with a 95 cm high decorative headboard
- The possibility of adding drawers 51 cm deep, available as an option
- A set of two hanging bedside cabinets with drawers
- A chest of drawers with one door and 3 drawers
- A 4-door 2-drawer wardrobe with a storage area, two hanging areas and a large central mirror



3304L140 : L149 x H95 x D199
Weight : 45 kg - Volume : 0,097m3
Number of packages : 2

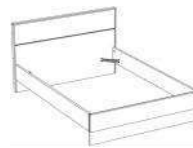

3304L260 : L169 x H95 x D209
Weight : 49 kg - Volume : 0,108m3
Number of packages : 2



3304TIRO : L189 x H17 x D51
Weight : 12 kg - Volume : 0,029m3



3304CHES : L43 x H95 x D43
Weight : 24 kg - Volume : 0,047m3



3304COPT : L113 x H80 x D42
Weight : 41 kg - Volume : 0,089m3
Number of packages : 2



3304A4PT : L188 x H196 x D52
Weight : 138 kg - Volume : 0,249m3
Number of packages : 4

ADULT BEDROOM / Travel



✦ Designed to fit out small spaces, this storage bed combines a double bed function with a real storage space underneath, thanks to its flip-up bed base

✦ Very trendy, this storage bed in **Artisan Oak | Black Stipple** tones is perfect to bring a touch of personality in an adult or teenager bedroom

✦ This bed also has a reinforced platform (22 mm thick) to allow you to create your own universe according to your desires



The products are made of particleboards with a thickness of 15 and 22 mm
The drawers are equipped with a roller runner system, the bed base with shock absorbers

ARTISAN OAK

BLACK STIPPLE



The storage bed **TRAVEL** includes :

- A bed base with dimensions of 140x200 cm adaptable to 140x190 cm
- 2 storage compartments of 31 cm in depth and a storage compartment closed by a drawer located on the side of the bed
- A 22 mm thick and 203 cm long platform just above + a second shelf of 20 cm in depth
- A total of four 30 cm high storage compartments with two of them are 45 cm deep, and a second drawer located under the bed
- Two 11 cm high platforms above these compartments which can be used for storing shoe boxes for example

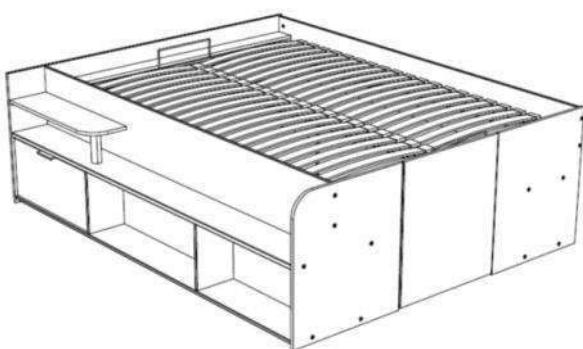

1540LICO : L166 x H67 x D206
Weight : 132 kg - Volume : 0.412m³
Number of packages : 5



LIVING ROOMS

SIDEBOARD / Axel



✚ A 120 cm long low-priced sideboard made up of 3 doors and 2 drawers offering a large storage volume for a small space requirement

✚ Available in **White** or **Brooklyn Oak**, this sideboard has neutral looking handles to fit any interior



Dimensions : L120 x H82 x D40
Weight : 39 kg - Volume : 0,077m³
5885E3PT : Brooklyn Oak version
5886E3PT : White version

The products are made of particleboards with a thickness of 15 mm

The drawers are equipped with a ball bearing runner system

BROOKLYN OAK

WHITE

LIVING ROOM / Fumay



✦ Give more character to your home with this contemporary living room in a modern combination of **Rough Oak** and **Dark Concrete** tones

✦ A collection of plush furniture with reassuring shapes and thicknesses for a relaxing and harmonious living room



The products are made of particleboards with a thickness of 15, 22 and 28 mm

The drawers are equipped with a roller system for the console and a ball bearing system for the TV bench

ROUGH OAK

DARK CONCRETE



The **FUMAY** modern-contemporary living room includes :

- a TV bench with a 22-mm-thick top, a door, a drawer and a storage compartment
- A coffee table with 28 mm thick crosspieces and two trays
- A TV wall unit with open and closed storage spaces for a TV up to 55 inches

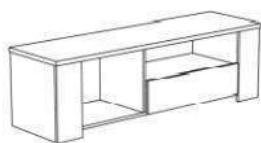

9432BATV : L138 x H41 x D40
Weight : 29 kg - Volume : 0,058m³



9432TABA : L105 x H37 x D73
Weight : 30 kg - Volume : 0,067m³



9432PATV : L166 x H138 x D41
Weight : 53 kg - Volume : 0,102m³
Number of packages : 2

LIVING ROOM / Helma



✚ Our complete Helma living room range has all the furnishing essentials in a timeless and contemporary style.

✚ Furnish your dining room with this spacious table with an extension that will allow you to welcome your **guest** in complete serenity. Practical, it can be stored under the table. With its sideboard and display cabinet, you can store your glasses and dishes as well as your decorative objects, thanks to the doors and niches.

✚ Its lounge items, coffee table and TV unit, will allow you to harmonize your living space furnishing while maximizing storage with doors and drawers.

✚ Its clean lines and its **Black Stipple** colour give elegance to the range, enhanced by the warm **Brooklyn Oak**. Helma is a safe bet that guarantees comfort and compatibility with all your home style.



The products are made in particle board with a thickness of 15 and 22 mm

BROOKLYN OAK

BLACK STIPPLE



The timeless and contemporary **HELMA** range includes :

- A 3-door, 1-drawer sideboard with 3 shelves
- A table with a 50cm extension to go from 157 to 207cm
- A display cabinet with 2 doors, 1 large drawer and 4 niches
- A TV unit with 2 doors, 2 drawers and 2 vertical niches
- A coffee table with a drawer and large storage space



0364TABA : L. : 110 cm ; H. : 42 cm ; P. : 66 cm; Weight : 31 kg ; Volume : 0.069 m3; Number of packages: 1



0364BATV : L. : 182 cm ; H. : 43 cm ; P. : 40 cm; Weight : 35 kg ; Volume : 0.074 m3; Number of packages : 1



0364TARE : L. : 157/207cm ; H. : 77 cm ; P. : 90 cm; Weight : 56 kg ; Volume : 0.123 m3; Number of packages : 2



0364E3PT : L. : 184 cm ; H. : 82 cm ; P. : 40 cm; Weight : 52 kg ; Volume : 0.112 m3; Number of packages : 2



0364BAHU : L. : 110 cm ; H. : 160 cm ; P. : 40 cm; Weight : 60 kg ; Volume : 0.116m3; Number of packages : 2

LIVING ROOM / Jules



✚ Modernity and elegance combine to create the Jules range with its authentic raw look, including a 4-door and 1-drawer sideboard, a 6-seater table, a 2-door and 1-drawer TV unit, 2-door and 1 drawer cabinet display and a coffee table.

✚ Compose your living room in an aesthetic and unique way by adopting the furniture of this complete and functional collection thanks to its storage spaces.

✚ Jules stands out for its two-tone Portofino Oak Grey | Steam Black colour and its workshop-style handles, giving it character and making this living room a perfect blend of contemporary and trendy industrial style.



The products are made of particleboard, with a thickness of 15, 22, 28 mm

GREY PORTOFINO
OAK

STEAM BLACK



The industrial and contemporary **JULES** living room includes:

- A 4-door sideboard with 2 interior shelves and 1 drawer, 218 cm long and 50 cm deep.
- A 180 cm long TV unit with 2 doors, 1 drawer and a niche.
- A 6-seater table, 200 cm long.
- A coffee table with 2 tops resting on industrial style legs.
- Cabinet Display

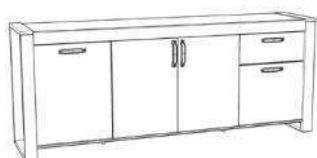

0355E4PT : L. : 218 cm - H. : 87 cm - P. : 50 cm ; Weight : 78kg; Volume : 0.164; Nb Packages: 3



0355TARE : L. : 200 cm - H. : 78 cm - P. : 100 cm; Weight : 57kg; Volume : 0.125 ; Nb Packages : 2



0355BATV : L. : 180 cm - H. : 49 cm - P. : 50 cm; Weight : 48kg; Volume : 0.102 ; Nb Packages: 2



0355TABA : L. : 110 cm - H. : 46.5 cm - P. : 66 cm; Weight : 30kg; Volume : 0.064 ; Nb Packages : 1



0355BAHT : L. : 107 cm - H. : 187 cm - P. : 40 cm; Weight : 65kg; Volume : 0.127 ; Nb Packages: 2

COFFEE TABLE / Nala



A coffee table that can be adjusted at will !

✦ This coffee table is equipped with a sturdy **360° swivel top** that is easy to unfold, allowing you to expand it whenever you want

✦ The two large storage areas under the top can be used to store all kinds of objects.

✦ This beautiful piece of furniture in natural **Japanese Oak | White** tones also integrates a claustra for a trendy and contemporary look



9220TABA : L110 x H50 x D60
Weight : 38 kg - Volume : 0,082m3

LIVING ROOM / Portland 2



✦ Our must have natural and contemporary living room has been reinvented in a more authentic and friendly version, discover PORTLAND 2

✦ A range with reassuring lines, both rounded and straight, that will enable you to entertain comfortably thanks to its extendable table and 4-door sideboard with its nice optional top unit adding function and freshness. Portland 2 also offers more compact storage to suit your needs, with a 140cm fixed table, a 3-door sideboard and a bookcase with open and closed storage.

✦ Its coffee table and TV unit are designed in a warm, traditional style to match your living room with your dining room.

✦ Portland 2 is a timeless value with a charming **Kronberg Oak** colour. This natural living room will easily find its place in your living space and will suit all your decorating styles.



The products are made of particleboard, 15, 18 and 22 mm thickness.

Drawers are fitted with a roller runner system + shock absorbers

KRONBERG OAK

LIVING ROOM / Portland 2



The PORTLAND 2 authentic living room includes :

- A 156cm long table with a 35cm extension
- A 140cm fixed table
- Two sideboards of 3 and 4 doors with inside shelves
- A top unit with 4 niches designed to complete the storage of the 4-door sideboard
- A bookcase with 2 doors and 3 niches
- TV unit with 2 doors and 2 horizontal niches
- A coffee table with a lower shelf



0347TARE : L156/191 x H78 x P90
weight : 54 kg - Volume : 0,117m3
Number of packages : 2



0347REHA : L196 x H84 x P31
weight : 35 kg - Volume : 0,073m3
Number of packages : 1



0347TA14 : L138 x H77 x P80
weight : 35 kg - Volume : 0,088m3
Number of packages : 1



0347BI2P : L110 x H185 x P43
weight : 68kg - Volume : 0.142m3



0347EN4P : L197 x H82 x P43
weight : 61 kg - Volume : 0,125m3; Number of packages : 2



0347BATV : L151 x H45 x P43
weight : 29 kg - Volume : 0,066m3
Number of packages : 1



0347EN3P : L153 x H82 x P43
weight : 49 kg - Volume : 0,106m3; Number of packages : 2



0347TABA : L110 x H 42 x P63
weight : 24 kg - Volume : 0,061m3
Number of packages : 1



✦ Enhance your living room with the unique and functional Shade coffee table and TV unit.

✦ Designed to accommodate a 50" TV, Shade integrates storage: 2 shelves on each side framing the TV, 2 doors next to a niche with a shelf allowing you to put your TV box or your Console.

✦ The coffee table will bring further storage thanks to the large space under the table top. Its design is developed to create an harmonious atmosphere with the TV unit.

✦ The claustra type profile panels give an openwork look to this range in natural and luminous **Japanese Oak** and **Home White** colours.



The products are made of particle board, with a thickness of 15 and 22 mm

WHITE

JAPANESE OAK



The **SHADE** TV unit includes:

- Space for a 50" TV
- 4 side shelves in Japanese Oak and one large shelf creating two niches
- Designed with cable management
- A coffee table with 6 claustra-type panels
- Large storage space under the table top

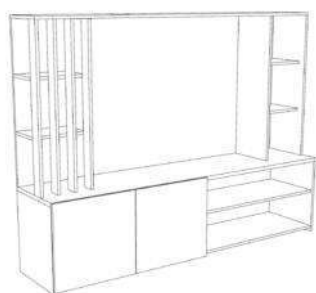

9836MUTV : L. : 184 cm - H. : 138 cm - P. :
41 cm ; Weight : 55 Kg; Volume : 0.117 ;
Number of packages : 2

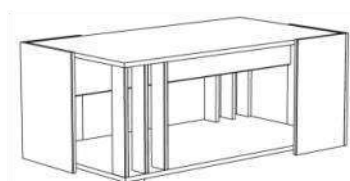

9836TABA : L. : 119cm - H. : 43cm - P.
: 68cm ; Weight : 29Kg; Volume :
0.068m³ ; Number of packages : 1

TV STAND / Tomy 2



✦ Very convenient, this TV stand has a **large storage capacity** that can accommodate several multimedia devices and an open space at the back to allow cable management

✦ It is also equipped with a sliding door, which is ideal for small spaces

✦ Opt for a **Jackson Oak | Steam Black** color combination enhanced by a black handle for a trendy look

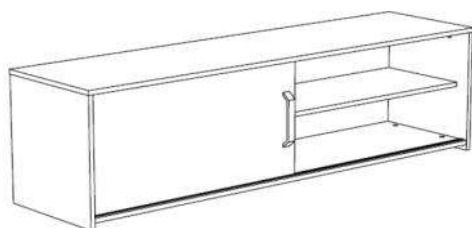

9300BATV : L155 x H43 x D40
Weight : 24 kg - Volume : 0,048m3



✦ A table—sideboard set with an **industrial** style, large feet and a trendy two-tone decoration in **Dark Grey | Artisan Oak**

✦ A quality finish, with ABS edges, metal handles and decorative apparent bolts

✦ A functional collection with marked lines revealing numerous storage spaces through reassuring shapes



0397TABL : L224 x H78 x D90/93
Weight : 57 kg - Volume : 0,127m³
Number of packages : 2



0397E3PT : L220 x H87 x D52
Weight : 92 kg - Volume : 0,182m³
Number of packages : 3

The products are made of particleboards with a thickness of 15 and 22 mm
The drawers are equipped with a roller runner system and metal handles



✦ A **natural** and **contemporary** living room with a **Dakota Oak** tone, an original shaped cut-out and ergonomics handgrips for a warm and welcoming interior

✦ A collection of **essential** furniture for the living room at an attractive price, including a 160 cm long table, a TV bench with open and closed storage compartments as well as a 4-door sideboard



DAKOTA OAK

The products are made of particleboards with a thickness of 15 and 22 mm
The drawers are equipped with a roller runner system



The contemporary living room **WENDY** includes :

- A 160 x 90 cm table with rounded shapes and 50 mm thick feet
- A TV bench with a storage compartment closed by a shaped door and two open storage compartments
- A 185 cm long sideboard composed of 4 doors, a central drawer and 27 mm thick right and left mouldings



0191TARE : L160 x H77 x D90
Weight : 39 kg - Volume : 0,078m3
Number of packages : 2

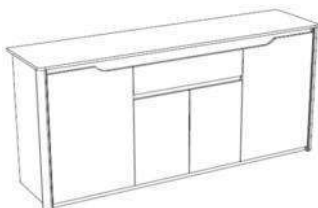

0191ENFI : L185 x H86 x D46
Weight : 63 kg - Volume : 0,128m3
Number of packages : 2

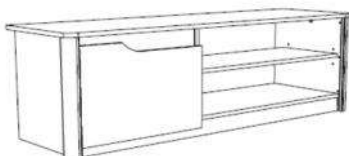

0191BATV : L136 x H42 x D40
Weight : 23 kg - Volume : 0,046m3



STORAGES & FURNITURES

STORAGE / Celest



✚ Need to organise and dress up your entry hall ?
Discover our Celest range

✚ A range designed to respond to all your storage needs with its sideboard its 3-door and 2-drawer sideboard, its 2-door sideboard and its two versions of shoe cabinets including: a 4-flap model and a second with 2 flaps and 1 drawer.

✚ The Celest range fits into any room in the house, thanks to its shallow depths and timeless colours. The warm Brooklyn Oak is contrasted by its Black Stipple pieces and the fine lines of the handles.



*The products are made in particleboard, with a thickness of 15 mm
Drawers are fitted with a metal ball bearing runner system*

BROOKLYN OAK

BLACK STIPPLE



CELEST storage range includes:

- A 3-doors and 2 drawers sideboard with 2 shelves inside
- A 2-doors cupboard with 2 shelves inside
- A 1.5m high shoe cabinet with 4 flaps and removable compartments
- A 1m high shoe cabinet with 2 flaps with removable compartments and 1 drawer



0982BAPT : L118 x H83 x P40cm
 Weight : 38 kg - Volume : 0,077m3
 Number of packages : 1

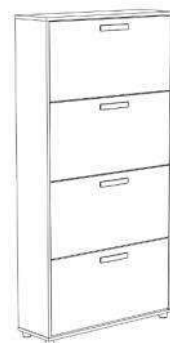

0982MCH4 : L78 x H154 x P24cm
 Weight : 29 kg - Volume : 0,078m3
 Number of packages : 1

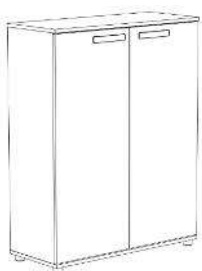

0982BA2P : L80 x H103 x P33cm
 Weight : 25 kg - Volume : 0,058m3
 Number of packages : 1

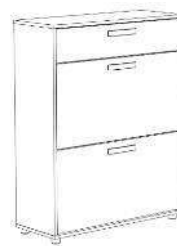

0982MCH2 : L80 x H103 x P30cm
 Weight : 26 kg - Volume : 0,056m3
 Number of packages : 1

STORAGE / Daily 2



✦ The Daily range has been reinvented with storage units that are ever more functional and adapted to your needs. Daily 2 is perfected by improving the ease of its assembly and thus your comfort!

✦ Available in the sober tones **White** or **Sonoma Oak**, this range combines great storage capacity and aesthetics by harmonizing with all your decoration styles.

✦ 185 cm high wardrobes available in **3 widths**: 81, 120 or 160 cm with **3 configurations**: doors, doors + drawers or doors + drawers + mirrors to easily adapt to your needs



SONOMA OAK

WHITE

The products are made of particleboards, with a thickness of 15 mm
The drawers are equipped with a ball-bearing runner system



The new **DAILY 2** storage range includes:

- A wardrobe available with two, three or four doors (for a total length of 81, 120 or 160 cm) equipped with grey aluminum finish plastic handles.
- A closet bar and several storage niches according to the model
- New generation drawers with easy assembly



Dimensions : L81 x H185 x P51
 Weight : 68 kg - Volume : 0,137m3
 Number of Packages : 2
6510A2PM : White
6511A2PM : Sonoma Oak



Dimensions : L81 x H185 x P51
 Weight : 65 kg - Volume : 0,133m3
 Number of Packages : 2
6510A2PT : White
6511A2PT : Sonoma Oak



Dimensions : L120 x H185 x P51
 Weight : 79 kg - Volume : 0,158m3
 Number of Packages : 2
6510A3PT : White
6511A3PT : Sonoma Oak



Dimensions : L120 x H185 x P51
 Weight : 82 kg - Volume : 0,162m3
 Number of Packages : 2
6510A3PM : White
6511A3PM : Sonoma Oak



Dimensions : L160 x H185 x P51
 Weight : 107 kg - Volume : 0,213m3
 Number of Packages : 3
6510A4PT : White
6511A4PT : Sonoma Oak



Dimensions : L160 x H185 x P51
 Weight : 114 kg - Volume : 0,218m3
 Number of Packages : 3
6510A4PM : White
6511A4PM : Sonoma Oak



Design your dressing room as you want it !

+ **EXTENSO** is an innovative wardrobe line, offering multiple possibilities for layout, functionality and aesthetic combinations

+ Create the storage solution you want, whether linear or angled, open or closed, thanks to our 23 references, including :

- 2 structure decors
- 7 front models



The products are made of particleboards with a thickness of 15 and 18 mm

STORAGE / Extenso



STRUCTURES L 50 & L 100

- + The structures are available in **White** or **Brooklyn Oak** with a textile coloured base and incorporate a shelf and a hanging bar
- + They also feature a self-centring assembly system for quick assembly and optimum security

A corner kit can also be used to create a corner module when combined with a L100 structure



Dimensions : L100 x H232 x D59
 Weight : 61 kg - Volume : 0,122m3
 Number of packages : 2
4430CA10 : White version
4432CA10 : Brooklyn Oak version



Dimensions : L50 x H232 x D59
 Weight : 47 kg - Volume : 0,093m3
 Number of packages : 2
4430CA50 : White version
4432CA50 : Brooklyn Oak version



Dimensions : L98 x H232 x D33
 Weight : 48 kg - Volume : 0,099m3
 Number of packages : 2
4430ANGL : White version
4432ANGL : Brooklyn Oak version



0042RA10 : L96 x H4 x D50
 Weight : 11,5 kg - Volume : 0,020m3



0042RA50 : L46 x H4 x D50
 Weight : 6 kg - Volume : 0,010m3



0043TI10 : L96 x H27 x D50
 Weight : 10 kg - Volume : 0,020m3



0043TI50 : L46 x H27 x D50
 Weight : 7 kg - Volume : 0,015m3



0044TI12 : L96 x H54 x D50
 Weight : 19 kg - Volume : 0,035m3



0044TI52 : L46 x H54 x D50
 Weight : 14 kg - Volume : 0,028m3



0045TIPP : L96 x H16 x D50
 Weight : 9 kg - Volume : 0,020m3



0049BA10 : L96 x H3 x D1,5
 Weight : 0,4 kg - Volume : 0,001m3



0048SPL2 : L35,5 x H4 x D16
 Weight : 1 kg - Volume : 0,008m3



4430FILE : L10 x H232 x D1,8
 Weight : 3 kg - Volume : 0,006m3

STORAGE / Extenso



Brooklyn Oak

4432PB50

L49,9 x H229 x D1,5

Weight : 13 kg

Volume : 0,065m³



White

4430PB50

L49,9 x H229 x D1,5

Weight : 13 kg

Volume : 0,065m³



Blanc + Mirror

4442PBCA

L49,9 x H229 x P1,9

Poids : 16 kg

Volume : 0,073m³



Glossy White

4436PB50

L49,9 x H229 x D1,5

Weight : 13 kg

Volume : 0,065m³



Mirror

4434PB50

L49,9 x H229 x D1,9

Weight : 13 kg

Volume : 0,065m³



Black Stipple

4445PB50

L49,9 x H229 x D1,5

Weight : 14 kg

Volume : 0,068m³



Black + Mirror

4433PB50

L49,9 x H229 x D3,5

Weight : 18 kg

Volume : 0,065m³

STORAGE / Galaxy



✚ A complete range including a 6-door and 3-drawer wardrobe, a 4-drawer chest, a bedside table with 1 drawer and a desk with 3 drawers.

✚ A whitelook enhanced by modern feet and handles for any bedroom.



The products are made of particleboards with a thickness of 12,5 and 15 mm
The drawers are equipped with a ball-bearing runner system

WHITE

STORAGE / Galaxy



The **GALAXY** storage range includes :

- A 120-cm-long desk with 3 drawers
- A bedside table with 1 drawer
- 1 chest 4 drawers of 25 cm high and 40 cm deep
- A 203-cm-high wardrobe with 6 doors and 3 drawers



5350CH1T : L40 x H41 x P33
WEIGHT: 8 kg - Volume : 0,017m³



5349BURE : L120 x H75 x P50
WEIGHT: 25 kg - Volume : 0,056m³

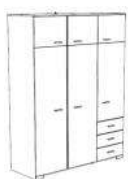

5366A6PT : L146 x H203 x P55
WEIGHT: 106 kg - Volume : 0,199m³
NUMBER OF PACKAGES: 4



5354CO4T : L77 x H106 x P40
WEIGHT: 32 kg - Volume : 0,068m³

BOOKCASE / Gaming



Lay it out the way you like!

✦ A bookcase with a completely customisable layout with its two trapezoidal doors that can be positioned on the left or on the right

✦ The shaped doors reveal part of the storages and highlight the central display niche composed of a glass shelf lit by a discreet LED kit



BLACK STIPPLE

The products are made of particleboards with a thickness of 15 and 22 mm

BOOKCASE / Gaming



✦ Very trendy, this beautiful bookcase in **Black Stipple** colour will easily find its place in your interior, becoming a real asset for your decoration

✦ Combine several bookcases to create an original shape, according to your wishes



6940BI2P : L67 x H180 x D28
Weight : 32 kg - Volume : 0,073m3
Number of packages : 2

HALL CABINET / Ghost



Brighten up your home with the Ghost cabinet!

✚ This very functional cabinet has all the necessary storage space to become indispensable: a wardrobe area, three storage compartments, a drawer as well as a lower storage unit with a sliding door

✚ Inspired by the *Japandi* trend and endowed with sober and pure lines, this elegant cabinet in **Japanese Oak | White** and **Artisan Oak | Black Stipple** tones also integrates a claustra creating a soft and bright atmosphere



L110 x H183 x D40

Weight : 48 kg - Volume : 0,096m³

Number of packages : 2

7628VEST : Japanese Oak / White

7629VEST : Artisan Oak / Black Stipple

The products are made of particleboards with a thickness of 15 mm

The drawers are equipped with a roller runner system

JAPANESE OAK

WHITE



✚ The **Legend** bookcase looks like a showcase thanks to its three glass shelves equipped with white LEDs, whose intensity can be adjusted by remote control, which will highlight the figures of the Gamer.

✚ Legend brings to the room a storage solution, with its **shelves**, and its two **doors** allowing to store its gaming equipment among others.

✚ Its aesthetics are in line with the Gaming universe thanks to its **Black Stipple** color and its asymmetrical doors. These characteristics allow the furniture to perfectly match its ambiance.



The products are made of particle board, with a thickness of 15 mm

DAK GEY

BLACK STIPPLE

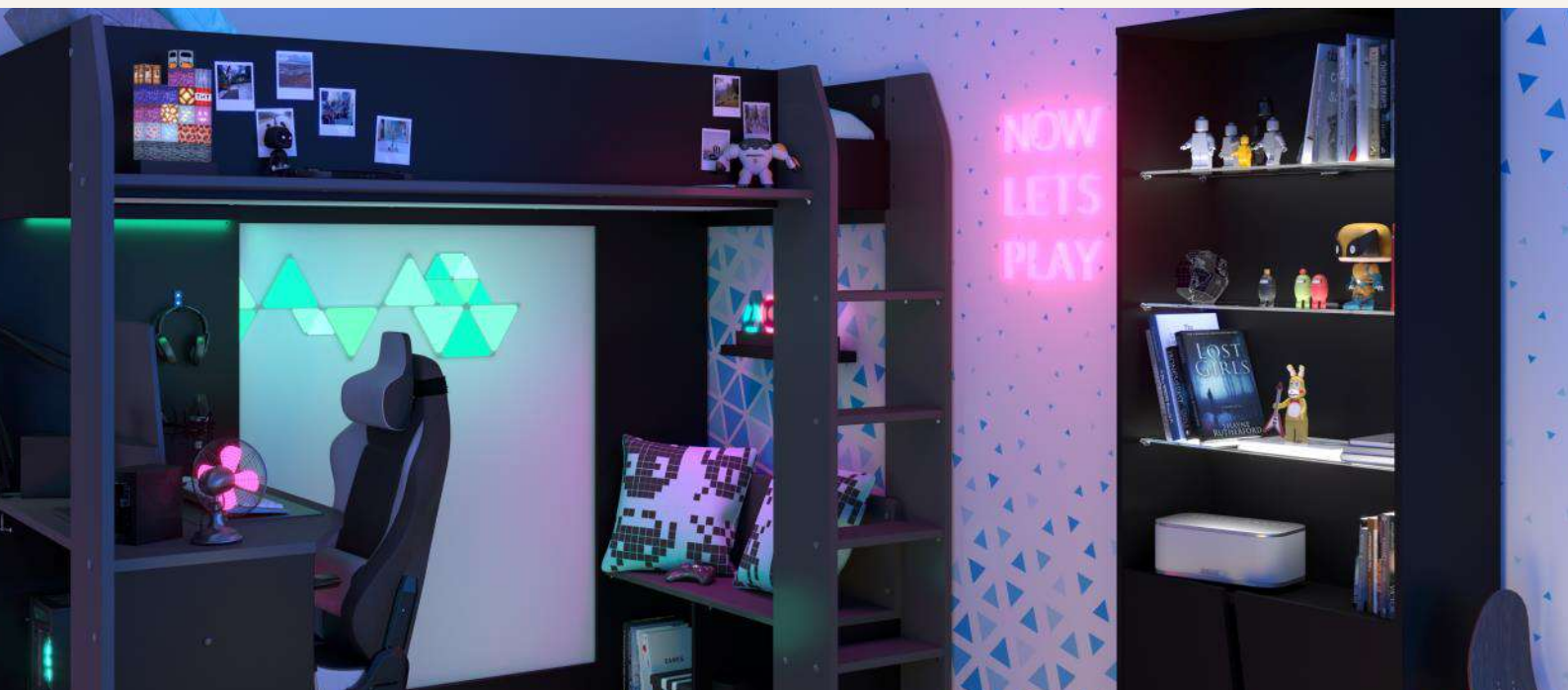

The **LEGEND** Functional Gaming Library includes:

- 3 glass shelves of 64cm length and 20cm depth.
- Clips kit 3 white Leds on each shelf with cable, converter, plug and remote control
- Spacious storage with shelf and two asymmetrical doors



2382BI2P : L67 x H180x P28
Weight : 31 kg - Volume : 0.072m3
Number of packages : 1

FILING CABINET / Ludik



✚ A range of storage units for files and documents designed to offer maximum storage capacity with **minimum space requirements**

✚ The drawers are equipped with metal rods to hang your files. The top drawer is also equipped with a **key lock**

✚ These storage units are perfectly adapted to the **SOPHIA** bookcase range and are also available in three colours (**White, Dakota Oak, Silver Walnut**)



Dimensions : L44 x H106 x D40

Weight : 22 kg - Volume : 0,05m³

9843CLAS : White version

9845CLAS : Silver Walnut version

9846CLAS : Dakota Oak version

The products are made of particleboards with a thickness of 15 mm

The drawers are equipped with a roller runner system

WHITE

DAKOTA OAK

SILVER WALNUT

STORAGE / Margaux



✦ Chic and elegant, the **Margaux** furniture program has a qualitative design thanks to its mouldings and the quality of its finishes for a for a style full of « charm »

✦ The patinated metal handles perfectly match the two universal colors available: **White** or **Pebble Grey** for a timeless look

✦ A complete bedroom with 2 sizes of wardrobes available, chest of 4 drawers and a bedside table



The products are made of particleboards with a thickness of 15 and 22 mm

The drawers are equipped with a roller runner system

WHITE

PEBBLE GREY

STORAGE / Margaux



The charming styled MARGAUX storage range includes:

- Two 202-cm-high wardrobes with 2 or 4 doors
- Chest of 4 drawers, 46-cm-deep drawers with handles in patinated metal
- A 58-cm-high bedside table with two drawers and a storage compartment



Dimensions : L85 x H104 x D46
 Weight : 44 kg - Volume : 0,088m³
 Number of packages : 2
3540CO4T : White version
3840CO4T : Pebble Grey version



Dimensions : L104 x H202 x D53
 Weight : 64 kg - Volume : 0,142m³
 Number of packages : 2
3540A2PT : White version
3840A2PT : Pebble Grey version



Dimensions : L45 x H58 x D42
 Weight : 15 kg - Volume : 0,033m³
3540CH2T : White version
3840CH2T : Pebble Grey version



Dimensions : L200 x H202 x D53
 Weight : 129 kg - Volume : 0,260m³
 Number of packages : 4
3540A4PT : White version
3840A4PT : Pebble Grey version

BOOKCASE / Mayence



✚ MAYENCE consists of several bookcases that can be combined indefinitely .

✚ The range includes a practical desk that can also be combined with the bookcases. So adapt your workspace to your storage needs !

✚ Various options can be available such as doors or decorative glass doors in "workshop" style or simple doors.

✚ Mayence adapts to your wishes. You can combine the sizes you like with the options you want. They are available in three colours, **Home White**, **Black Oak** and **Japanese Oak**, depending on your preferences.

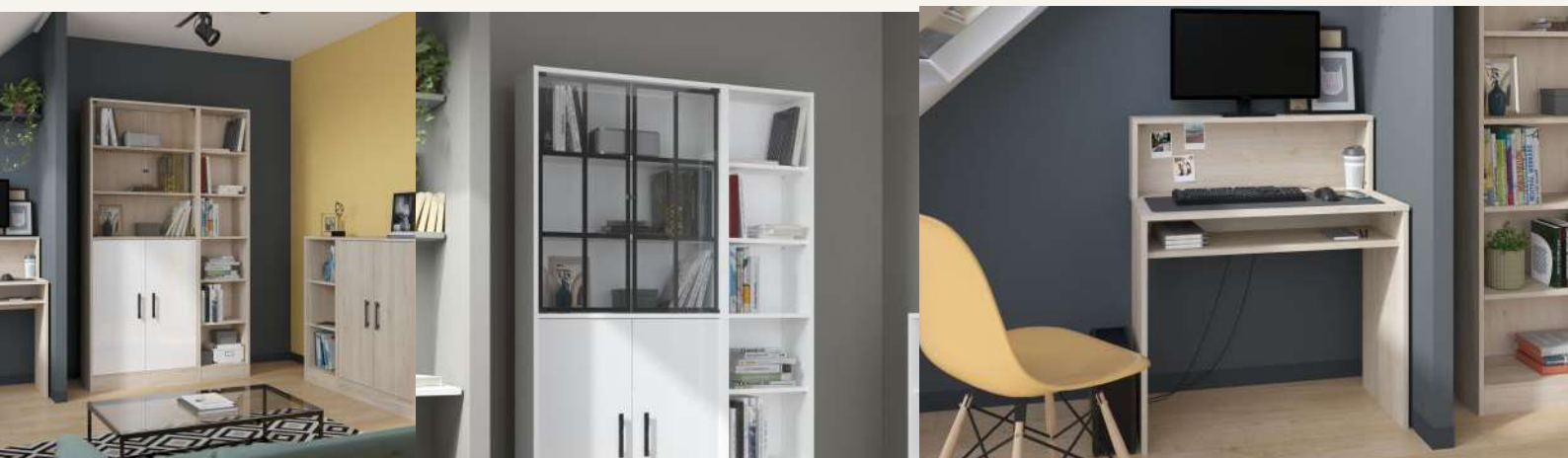

The products are made of particleboards with a thickness of 18 mm.

WHITE

JAPANESE
OAK

CABEZONE
OAK



The **MAYENCE** bookcase range includes:

- 4 storage sizes : a tall bookcase, a narrow tall bookcase and 2 low bookcases available in 3 colours.
- 1 Japanese oak desk with a niche and a hutch that can be combined with the bookcases.
- An option of industrial style glass doors or standard glass doors.
- A door option available in Home White, Japanese Oak and Black Oak.



L. : 79 cm - H. : 198 cm - P. : 28 cm
BIBBL Modéle:

8243BIBL : WHITE

8241BIBL : CABEZONNE

8242BIBL : JAPANESE OAK



L. : 41 cm - H. : 198 cm - P. : 28 cm
COLO Modéle:

8223COLO : WHITE

8221COLO : CABEZONNE

8222COLO : JAPANESE OAK



L. : 41 cm - H. : 104 cm - P. : 28 cm
BIBU Modéle:

8263BIBU : WHITE

8261BIBU : CABEZONNE

8262BIBU : JAPANESE OAK



L. : 79 cm - H. : 104 cm - P. : 28 cm
BIBU Modéle:

8283BIBU : WHITE

8281BIBU : CABEZONNE

8282BIBU : JAPANESE OAK



8322BURE : L. : 91 cm - H. : 105 cm
- P. : 50cm weight 21kg Nb of package :1



L. : 35 cm - H. : 91 cm - P. : 1 cm
PORV Modéle:

8315PORV : VERRE ATELIER

8316PORV : SANS SERIGRAPHIE



L. : 71 cm - H. : 91 cm - P. : 1,5 cm
PORP Modéle:

8291PORP : BLACK OAK

8292PORP : JAPANESE OAK

8317PORP : SHINING WHITE

FILING CABINET / Milo



✚ A range of three and four drawer file and document cabinets with generous storage capacities

✚ The drawers are equipped with metal rods to hang your files. The top drawer is also equipped with a key lock

✚ These filing cabinets with Japanese Oak fronts have White or Black Stipple surrounds and handles for a soft, natural atmosphere



Dimensions : L44 x H106 x D40
Weight : 24 kg - Volume : 0,05m³
7424CLAS : White | Japanese Oak version
7426CLAS : Black Stipple | Japanese Oak version



Dimensions : L44 x H138 x D40
Weight : 31 kg - Volume : 0,064m³
7425CLAS : White | Japanese Oak version
7427CLAS : Black Stipple | Japanese Oak version

The products are made of particleboards with a thickness of 15 mm

The drawers are equipped with a roller runner system

JAPANESE OAK

WHITE

JAPANESE OAK

BLACK STIPPLE

STORAGE / Minkee



✦ Did you like our Minkee wardrobe ? Let yourself be seduced by its Black version !

✦ Rediscover an elegant 3-door wardrobe with a mirror and a 5 shelf storage space, a hanging rail and two drawers with a roller runner system

✦ The charming leather handles on the MINKEE wardrobe are very comfortable to use and add a touch of sophistication. Available in White et now in Black Stipple, Minkee never ceases to surprise you while keeping its function and aesthetics clean and elegant.



The products are made in particleboards, with a thickness of 15 mm

The drawers are equipped with a roller runner system

BLACK STIPPLE

WHITE

STORAGE / Minkee



MINKEE wardrobes include :

- 3-door wardrobe with mirror and 2 drawers
- 1/3 storage space with 5 shelves
- 2/3 storage space with hanging rail and top shelf
- 4 leather handles

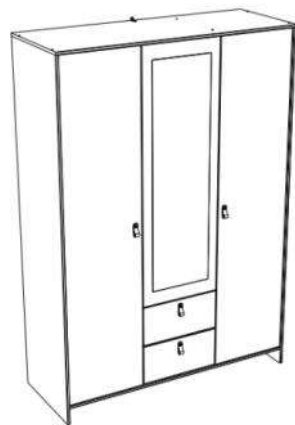

L137 x H196 x P52cm

Weight : 103 kg - Volume : 0,199m³

Number of packages : 3

6482A3PT : White

6492A3PT : Black

STORAGE / Orlando



✦ A 38 cm deep wardrobe with two doors and one drawer perfect for small spaces thanks to its small footprint

✦ Orlando is suitable for all ages and all your storage needs. You can easily use it in a bedroom, an office or an entry hall.

✦ Available in 3 colours, this wardrobe with its pure lines adapts to your taste and style. Choose **Home White** for a sober and bright look, **Sonoma Oak** for a cosy and warm atmosphere, or its trendy industrial version in **Brooklyn Oak** and **Black Stipple**.



The products are made of particleboard with a thickness of 15 mm

The drawers are equipped with a ball bearing runner system

SONOMA OAK

WHITE

BROOKLYN OAK

BLACK STIPPLE



The timeless **ORLANDO** storage range includes :

- 2-door wardrobe with 1 large drawer available in 3 colours : White, Sonoma Oak and its two-tone version in Brooklyn Oak and Black Stipple.
- Interior fittings with 3 shelves and a large drawer of 80 x 40 cm.
- 4 handles



Dimensions : L78 x H170 x P38

Weight : 47 kg - Volume : 0,095m3

Number of packages : 2

6580A2PT : White

6581A2PT : Sonoma Oak

6582A2PT : Brooklyn Oak/Black Stipple

BOOKCASE / Sophia



✚ A range of 18 mm thick and 28 cm deep bookcases with a woven linen effect bottom for an affordable qualitative finish!

✚ These bookcases are available in four different sizes and three different colours (White, Dakota Oak, Silver Walnut)

✚ Glossy White doors are also available



WHITE

DAKOTA OAK

SILVER WALNUT

The products are made of particleboards with a thickness of 18 mm

BOOKCASE / Sophia



The **SOPHIA** bookcase range includes :

- Four 28 cm deep bookcase models, available in widths of 41 cm or 79 cm and heights of 104 cm or 198 cm
- A choice of three colours (**White, Dakota Oak, Silver Walnut**)
- The possibility of adding doors in the colours of the different bookcases but also in **Glossy White**



Dimensions : L41 x H198 x D28
 Weight : 25 kg - Volume : 0,05m3
8400COLO : Silver Walnut version
8410COLO : Dakota Oak version
8420COLO : White version



Dimensions : L79 x H198 x D28
 Weight : 35 kg - Volume : 0,074m3
8401BIBL : Silver Walnut version
8411BIBL : Dakota Oak version
8421BIBL : White version



Dimensions : L41 x H104 x D28
 Weight : 14 kg - Volume : 0,031m3
8402BIBU : Silver Walnut version
8412BIBU : Dakota Oak version
8422BIBU : White version



Dimensions : L79 x H104 x D28
 Weight : 19 kg - Volume : 0,042m3
8403BIBU : Silver Walnut version
8413BIBU : Dakota Oak version
8423BIBU : White version



Dimensions : L75 x H91 x D1,5
 Weight : 8 kg - Volume : 0,021m3
8405PORP : Silver Walnut version
8415PORP : Dakota Oak version
8425PORP : White version



8427POR2 : L75 x H91 x D1,5
 Weight : 8 kg - Volume : 0,021m3



DESKS

TROLLEY / Back Up



➕ Practical and space-saving, this 60 cm deep trolley on wheels has a spacious top and a hutch, both 92 cm wide, that can hold a complete workstation

➕ This clever unit also has a open compartment and a shelf for additional storage spaces

➕ This piece of furniture with its trendy Brooklyn Oak | Black Stipple decors will easily find its place in your home



9800INFO : L95 x H90 x D60
Weight : 29 kg - Volume : 0,064m³

DESK / Begin



✚ A reversible and compact corner desk with **plenty of storage spaces** : drawer, shelves, storage compartments and a shaped extension.

✚ With this desk you can store all your essentials and organise your workspace.

✚ Begin is a trendy industrial style desk in **Brooklyn Oak** contrasting with the interior storage and Black Stipple handle giving it character and depth.



9873BUAN : L121 x H102 x P106
Weight : 40 kg - Volume : 0,078m3
Number of packages : 2

DESK / Gaming

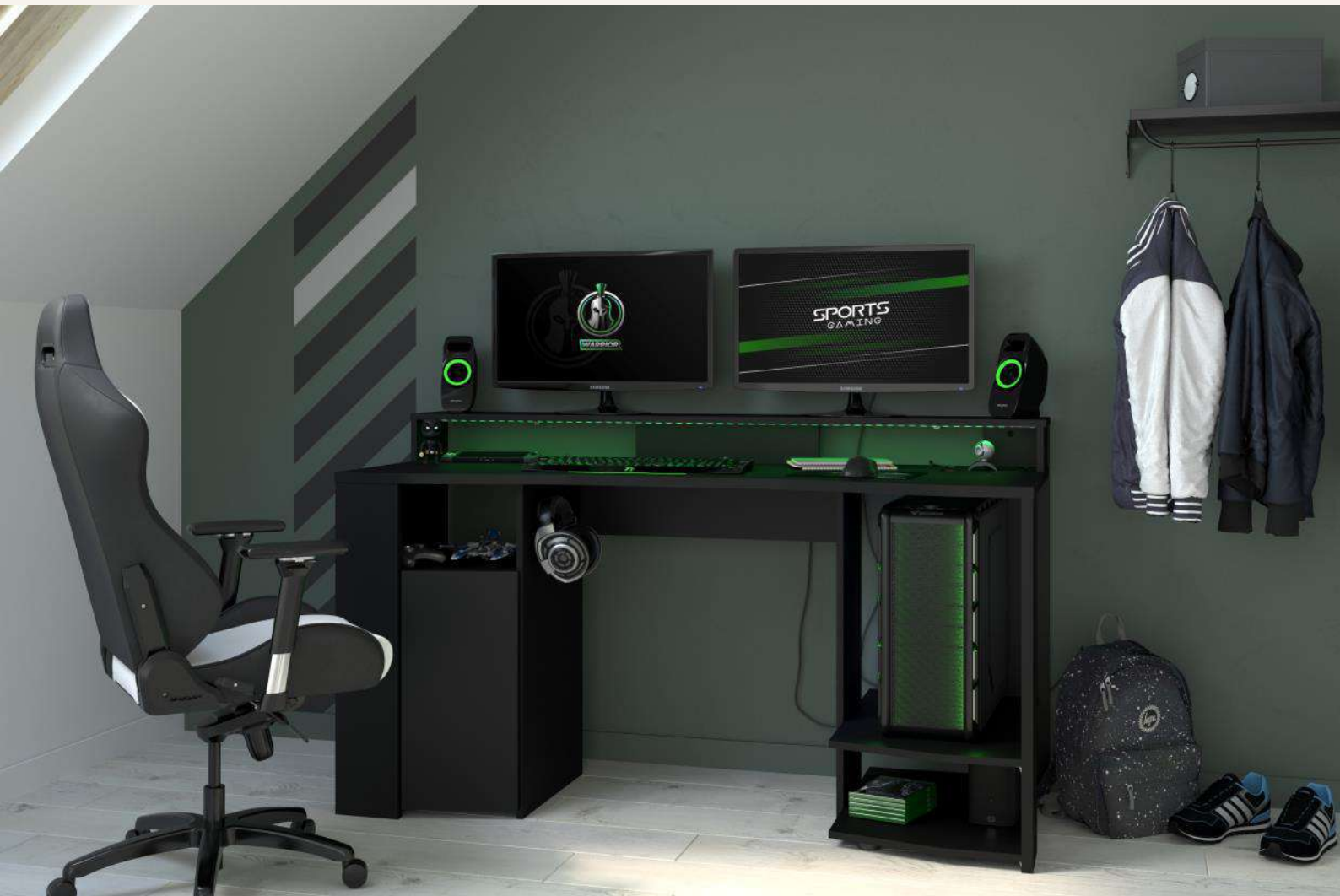

➤ Designed for **gamers**, this innovative desk is equipped with an extension that can hold multiple screens and an audio system

➤ Enjoy a large play area with an optical mouse-compatible surface for greater **freedom of movement**

➤ This desk also has an open space dedicated to the storage of a central unit, a storage space closed by a door and a headset holder

➤ Recreate the atmosphere of the greatest competitions with the **LED kit** with remote control included



The products are made of particleboards with a thickness of 15 and 22 mm

BLACK STIPPLE



The **GAMING** desk, designed to set up a play station includes :

- A 152 cm long x 62 cm deep gaming area with a 19 cm deep overhang that can accommodate multiple screens and an audio system
- A closed storage space (with a shelf) of 52 cm high x 40 cm deep
- An open space of 60 cm deep x 39 cm width dedicated to the storage of a central unit
- A second open space of 17 cm high located under the space dedicated to the central unit

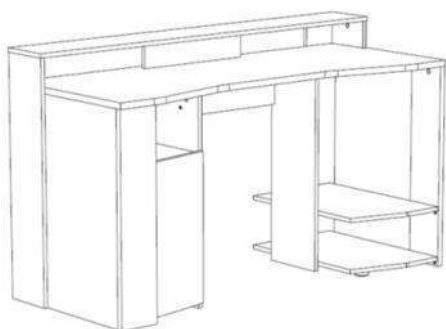

6940STAT : L152 x H87 x D62
Weight : 46 kg - Volume : 0,101m³
Number of packages : 2



✚ **Index** is a practical desk thanks to its castors. It is ideal for small spaces with its 78 cm length and the possibility to move it.

✚ This desk is a spacious digital desk with a niche for storing documents and a shelf at the bottom for storing books or files for example.

✚ This rolling desk is suitable for all interiors thanks to its dominant **Japanese Oak** colour and the second colour: **Black Stipple** for a trendy industrial style, or **Home White** for a modern and bright atmosphere. Index will fit in a bedroom as well as in your living room.



BLACK STIPPLE

WHITE

JAPANESE OAK

The products are made of particleboards with a thickness of 15 and 22mm



The functional and timeless **INDEX** desk includes :

- A 78 cm long and 50 cm deep top.
- A bottom shelf designed for large files.
- 1 niche under the top.
- 4 castors allow the desk to be mobile.



L : 78 cm X H : 77 cm X P : 50 cm

9852INFO : BLACK STIPPLE

9854INFO : WHITE

DESK / Infinity



✦ Functional and space-saving, the Infinity desk has a large top measuring 121 cm long x 55 cm deep and a large storage capacity with three 14 cm high drawers

✦ Choose your style with its 3 versions : **Light Acacia** for a warm atmosphere, **White** to bring luminosity or **Brooklyn Oak** and **Black Stipple** for a trendy industrial look or **White** and **Brooklyn Oak** for a soft natural look. This functional desk is ideal to create a work space at home !



The products are made of particleboard, with a thickness of 15 mm

The drawers are equipped with a ball bearing runner system

LIGHT ACACIA

WHITE

BROOKLYN OAK

WHITE

BLACK STIPPLE

BROOKLYN OAK
141

DESK / Infinity



The timeless **INFINITY** desk includes:

- A 121 cm long and 55 cm deep desk
- 3 drawers measuring 35 cm long and 31 cm deep
- 3 grey handles for the Acacia and White versions.
- 3 black handles for the Oak / Black version.
- 3 white handles for the White / Oak version.



Dimensions : L121 x H74 x P55

weight : 26 kg - Volume : 0,055m³

6193BUR1-ECR : Light Acacia

6493BUR1-ECR : White

6439BURE : Brooklyn Oak / Black Stipple

6440BURE : White / Brooklyn Oak

DESK / Level



✦ Create your atmosphere with the LEVEL Led kit desks

✦ This spacious gaming desk has a large surface area of 150 cm in length with a hutch that can accommodate two screens and a sound system to give you total immersion

✦ This desk is also equipped with a compartment for a central unit, a sliding shelf with carbon finish handle and an open storage space under the desk

✦ Choose the **Black Stipple** version for total immersion in the world of gaming, or the timeless, contemporary **Japanese Oak** and **White** version.



The products are made of particleboards with a thickness of 15 and 22 mm
The sliding shelf is equipped with a metal roller runner system

BLACK STIPPLE

JAPANESE OAK

WHITE

DESK / Level



The immersive gaming desk LEVEL includes :

- A 150 cm long x 58 cm deep gaming area with a shaped hutch that can accommodate multiple screens and a sound system
- A 70 cm high open storage area under the desk with a mid-height shelf
- A compartment for a central unit
- A sliding shelf with a carbon finish handle ideal for storing controllers or using as a secondary platform
- A LED kit with remote control included

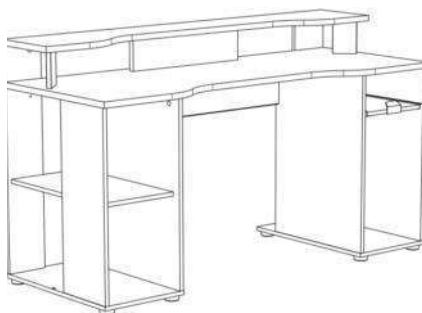

L150 x H90 x P60; Weight : 42 kg - Volume : 0,099m3; Number of packages : 2

6900STAT : Black Stipple

6901STAT : Oak / White

DESK / Minister



✚ A real "Minister's" desk designed to work, store and classify with a 22 mm thick desk, various closed storage units, a locked drawer and an additional open storage space under the desk

✚ A 77 cm high extension is also available as an option, including a 43 cm shelf and a 107 cm long storage niche with sliding door



9872BURE : L152 x H78 x D59
Weight : 48 kg - Volume : 0,098m3
Number of packages : 2



9872REHA : L151 x H77 x D28
Weight : 21 kg - Volume : 0,047m3

DESK / Mister



✦ A very functional desk with a large ergonomic surface and a **side bookcase**

✦ Space-saving, this **2-in-1** furniture is ideal to furnish a small room, a student's studio or to create a workspace in your living room

✦ Brighten up your home with this modern styled library desk in an elegant, timeless **white** !

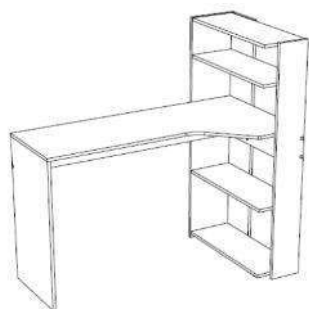

7419BURE : L122 x H121 x D64
Weight : 28 kg - Volume : 0,056m³

WHITE

The products are made of particleboards with a thickness of 15 mm

DESK / School



✚ A desk with a 101 x 50 cm working area and a drawer with ball bearing runner, all for an attractive price !

✚ A classic and timeless **White** colour that will suit both adults and children !

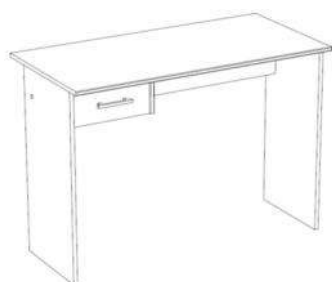

7067BURE : L101 x H74 x D50
Weight : 13 kg - Volume : 0,03m3

The products are made of particleboards with a thickness of 15 mm
The drawers are equipped with a ball bearing system

DESK / Set-Up



✦ Co-developed with the Webedia multimedia group, the Set-Up collection includes gaming desk with melamine covering that combine **ergonomics and functionality**

✦ Beautiful desk with spacious areas and numerous storage spaces enhanced with accessories (helmet hook, LED ribbon with remote control...) for maximum comfort

✦ An offer dedicated to players, whether they are novices or experienced, for a game in total immersion !



The products are made of particleboards with a thickness of 15 and 22 mm

The drawers are equipped with a roller runner system

DARK GREY

DESK / Set-Up



The **SET-UP** collection, designed to offer maximum comfort, includes :

- A 180 cm long desk which can accommodate 3 screens
- Carbon finish handles and remote controlled LED kit
- Remote controlled LED kit



7540STAT : L180 x H92 x D67
Weight : 56 kg - Volume : 0,125m³
Number of packages : 2

DESK / Start Up



✦ A range of **modular** and robust **desks** and **bookcases** to meet all furnishing needs

✦ A very contemporary style with a mix of **Artisan Oak** and **Shadow Grey** decors, highlighted by metal legs and **Aluminium Grey** coloured handles

✦ Options thought for today's uses (corner units to join desks together, cable management, locks ...)



The products are made of particleboards with a thickness of 15 and 22 mm

The drawers are equipped with a roller runner system

ARTISAN OAK

DARK GREY



The **START UP** modular desk and bookcase collection includes :

- Three desks with lengths of 120, 150 and 180 cm
- One corner to join two desks together without additional legs
- A desk with swivelling storage unit on wheels, cable management and a lock
- A three drawers unit with wheels and a lock
- Three bookcases with heights of 107, 175 and 210 cm
- A set of two bookcase doors with lock (one of which has two drawers)
- Two filing cabinets of 3 and 4 drawers with a lock



7958BU12 : L120 x H73 x D80 | Weight : 33 kg - Volume : 0.129m³ | Number of packages : 2

7958BU15 : L150 x H73 x D80 | Weight : 38 kg - Volume : 0.141m³ | Number of packages : 2

7958BU18 : L180 x H73 x D80 | Weight : 43 kg - Volume : 0.154m³ | Number of packages : 2



7958BURE : L158 x H73 x D67

Weight : 56 kg - Volume : 0,183m³

Number of packages : 3



7958ANGL : L80 x H2,2 x D80

Weight : 8 kg - Volume : 0,022m³

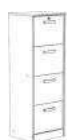

7965CLAS : L44,3 x H138,4 x D40,3

Weight : 31 kg - Volume : 0,064m³



7966CLAS : L44,3 x H106,4 x D40,3

Weight : 24 kg - Volume : 0,050m³



7959CAIS : L49 x H70 x D49

Weight : 24 kg - Volume : 0,061m³



7961BIBL : L83 x H107 x D41

Weight : 32 kg - Volume : 0,066m³



7962BIBL : L82 x H175 x D41

Weight : 51 kg - Volume : 0,094m³

Number of packages : 2



7963BIBL : L82 x H209 x D41

Weight : 59 kg - Volume : 0,110m³

Number of packages : 2



7964PORP : L78 x H100 x D1,5

Weight : 9 kg - Volume : 0,029m³



7964POTI : L78 x H100 x D37

Weight : 14 kg - Volume : 0,028m³



BEAUTY BARS

BEAUTY BAR / Aalborg



✦ Let yourself be seduced by the Aalborg beauty bar, which is as aesthetic as it is practical thanks to its large top and its top shelf, ideal for putting on your make-up or your jewellery!

✦ Its rounded mirror underlines the curves of the furniture and gives it softness and originality.

✦ Completing the range of the same name, the Aalborg beauty bar with its pure and rounded lines will find its place in your bedroom thanks to its colour combinations of **Japanese Oak | White** and **Japanese Oak | Black Stipple**.



The products are made of particleboards with a thickness of 15 and 22 mm

JAPANESE OAK

JAPANESE OAK

WHITE

BLACK STIPPLE



AALBORG beauty bar includes :

- 1 rounded mirror.
- A 90 cm long and 50 cm wide top .
- One 90cm long sand 15cm deep shelf .



L. : 90 cm - H. : 135 cm - P. : 50 cm

3500COIF : white | Japonase oak

3501COIF : Black Stipple | Japonese oak



✚ Furnish your room with real movie theater-style furniture with our **SWEET** and **VOLAGE** dressing tables! These beautiful corner furniture available in **White** and **White | Jackson Oak** will definitely find their place in your room

✚ Don't miss any more functionality with these innovative dressing tables equipped with 3 mirrors (including a central mirror illuminated by the included LED kit), a mobile/tablet support, several shelves as well as 5 drawers swiveling at



WHITE WHITE

JACKSON OAK

The dressing tables are made of particleboards with a thickness of 15 and 22 mm

BEAUTY BAR / Volage



Dimensions : L114 x H142 x D61

Weight : 38 kg - Number of packages : 2

7365COIF : White version - Volume : 0,078m3

7385COIF-ERC : White | Jackson Oak version - Volume : 0,091m3



PARISOT INDUSTRIE